

# INTRODUCTION

Congratulations! You have purchased one of the most sophisticated cordless telephones on the market! The **SBC9030** has been designed to offer a new standard in cordless telephone technology.

Unlike most other cordless phones, the **SBC9030** digitizes your voice using advanced digital voice coding to provide noise and distortion free performance. In most conditions you will not be able to tell you are using a cordless phone. Gone are the annoyances of static, interference and having to listen to other people's conversations on your cordless phone.

The **SBC9030** scrambles your voice before it transmits it. This allows you the security of knowing that no one can tune in and eavesdrop on your conversations.

The **SBC9030** decodes and displays name and number Caller ID (CID) information where available and when subscribed to. The alpha-numeric display will show both the name and number of the calling party (when available). Up to 15 name characters and/or 11 phone number digits can be displayed on the LCD.

With the **SBC9030**, the user can easily answer a call by pressing any key other than the OFF, VOLUME keys or 3 PPU keys. In addition, the handset keypad and LCD illuminate while the handset rings to signal an incoming call. This is very useful in a dark environment.

The **SBC9030** includes a **Speakerphone** and **keypad** on the Base Unit. This enables you to make and receive calls hands-free at the Base. In

addition, the Intercom feature allows two-way communication between the Handset and Base Unit. Pressing **INTERCOM** on the Base can also assist you in locating a misplaced Handset.

The **SBC9030** uses special memory in both the Base Unit and Handset which is not susceptible to power failures. This provides permanent storage of all speed dial numbers, CID information as well as the Base Unit and Handset security codes.

When a spare battery (not included) is installed in the Base Unit, the **SBC9030** uses this battery to provide operational backup in case of power failure. In this way, you have access to all normal phone functions during a total power outage. Calls can still be placed and received without interruption. More than 4 hours backup will be possible with a fully charged battery in the Base Unit.

The phone will also alert you when you are Out of Range even when you're not using the phone!

# INTRODUCTION

---

## SPECIAL FEATURES

---

- 900 MHz Operation.
- Direct Sequence Spread Spectrum - Digital Cordless Telephone.
- Digitally-Scrambled Voice Communication.
- Simultaneous display of Name, Number, and Time/Date stamp for Caller ID.
- 50 Caller ID memory locations.
- Voice announce Caller ID
- 4-row by 16-character dot matrix alphanumeric display.
- Backlit display on handset.
- Backlit handset keypad.
- Three Soft Keys which allow the user to access different functions, depending on which mode the phone is currently in (i.e. Caller ID, Memory Programming, etc.).
- Smart Dialing from Caller ID memory eliminates the need to pre-program your local area code.
- 25 locations Programmable Memory for 16-Digit Phone Number. Each location can also be assigned up to a 15 character name.
- Out of Range indication while the handset is in use or in standby mode.
- Handset speakerphone.
- Speakerphone and keypad on the Base Unit.
- Two-way intercom between Handset and Base Unit.
- Removable handset battery pack.
- Spare battery charger in the base unit.
- Complete battery back-up in case of power failure (with additional battery pack installed in base).
- Face up or down Handset charging.
- Easy answer - When the phone rings, simply press any key other than OFF, the Volume keys or the 3 PPU keys on the handset to answer.
- Pressing the **OFF** key on handset during incoming ring will stop the ringing.
- Auto hang up when returning the handset to the base cradle.
- 24-Bit Digital Security Code.
- Low Battery Detect and Warning indicator.
- Tone or Pulse dialing.
- Visual Message Waiting Indication (VMWI) for use with voicemail service.
- Up to 7 hours of continuous talk time or 14 days standby time.
- 8-level Volume control on Handset.
- Programmable Ringer Tones and Volume.
- Headset Compatible, for use with 2.5mm headsets.

This manual is designed to familiarize you with the **SBC9030**. We strongly recommend you read the manual before using your phone.

# INTRODUCTION

## PARTS CHECK LIST

1. Base Unit, Handset, Belt Clip and AC adapter
2. One-Line Telephone Cord

3. Battery Pack
4. Wall mount accessory

To purchase replacement battery packs, call Customer Service at 800-667-2118.



Handset

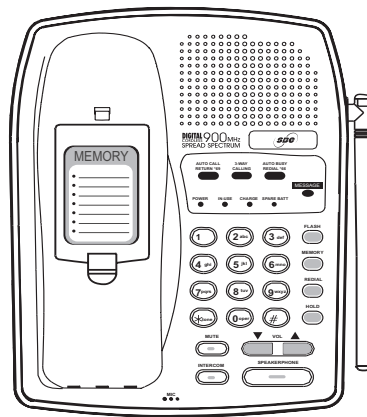

Base Unit



Belt Clip

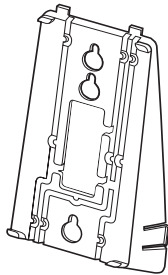

Wall mount accessory

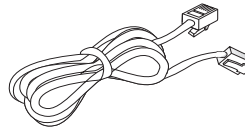

Telephone Cord

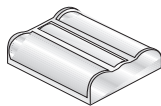

Battery Pack

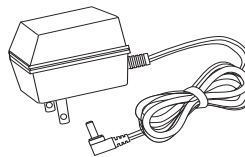

AC Adapter

# FCC REGULATIONS

This equipment complies with Parts 15 and 68 of the Federal Communications Commission (FCC) rules for the United States. Operation is subject to the following two conditions: (1) this device may not cause interference, and (2) this device must accept any interference, including interference that may cause undesired operation of the device.

The underside of the Base Unit containing engravements of either the FCC registration number and Ringer Equivalence Number (REN), or the IC registration number. You must, upon request, provide this information to your local telephone company.

This equipment is compatible with inductively coupled hearing aids.

Should you experience trouble with this telephone equipment, please contact:

**Customer Service at 800-667-2118**

The telephone company may ask you to disconnect this equipment from the line network until the problem has been corrected.

---

## FCC Part 15

---

Warning: Changes or modifications to this unit not expressly approved by the party responsible for compliance's could void the user's authority to operate the equipment.

The equipment has been tested and found to comply with part 15 of the FCC

rules. These limits are designed to provide reasonable protection against harmful interference in a residential installation. This equipment generates, uses and can radiate radio frequency energy and, if not installed and used in accordance with the instructions, may cause harmful interference to radio communications. However, there is no guarantee that interference will not occur in a particular installation. If this equipment does cause harmful interference to radio or television reception, which can be determined by turning the equipment off and on, the user is encouraged to try and correct the interference by one or more of the following measures:

- Reorient or relocate the receiving antenna.
- Increase the separation between the equipment and receiver.
- Connect the equipment into an outlet or on a circuit different from that to which the receiver is connected.
- Consult the dealer or an experienced radio/TV technician for help.

# FCC REGULATIONS

---

## FCC Part 68

---

The FCC requires that you connect your cordless telephone to the nationwide telephone network through a modular telephone jack (USOC RJ11C, RJ11W or RJ14).

Your telephone company may discontinue your service if your equipment causes harm to the telephone network. They will notify you in advance of disconnection, if possible. During notification, you will be informed of your right to file a complaint with the FCC.

Occasionally, your telephone company may make changes in its facilities, equipment, operation, or procedures that could affect the operation of your equipment. If so, you will be given advance notice of the change to give you an opportunity to maintain uninterrupted service.

The Base Unit contains no user serviceable parts. The Handset contains a user replaceable battery pack.

If it is determined that your telephone equipment is malfunctioning, the FCC requires that it not be used and that it be unplugged from the modular jack until the problem has been corrected. Repairs to this telephone equipment can only be made by the manufacturer or its authorized agents or by others who may be authorized by the FCC. For repair procedures, follow the instructions outlined under the Limited Warranty.

This equipment may not be used on coin service provided by the phone company or Party Lines.

The REN is useful in determining the number of devices you may connect to your telephone line and still enable the devices to ring when you receive a call. The general rule is that the REN value should not exceed 5.0 total; however, contact your local telephone company for the specific number in your area.

## IMPORTANT SAFETY INSTRUCTIONS

When using your telephone equipment, basic safety precautions should always be followed to reduce the risk of fire, electric shock and injury to persons, including the following:

1. Read and understand all instructions.
2. Follow all warnings and instructions marked on the product.
3. Unplug this product from the wall outlet before cleaning. Do not use liquid cleaners or aerosol cleaners. Use a damp cloth for cleaning.
4. Do not use this product near water (for example, near a bath tub, kitchen sink, or swimming pool).
5. Do not place this product on an unstable cart, stand, or table. The product may fall, causing serious damage to the product.
6. Slots and openings in the cabinet on the back or bottom are provided for ventilation. To protect it from overheating, these openings must not be blocked by placing the product on a bed, sofa, rug, or other similar surface. This product should never be placed near or over a radiator or heat register. This product should not be placed in a built-in installation where proper ventilation is not provided.
7. This product should be operated only from the type of power source indicated on the marking label. If you are not sure of the type of power supply to your home, consult your dealer or local power company.
8. Do not allow anything to rest on the power cord. Do not locate this product where the cord will be abused by persons walking on it.
9. Never push objects of any kind into this product through cabinet slots as they may touch dangerous voltage points or short out parts that could result in a risk of fire or electric shock. Never spill liquid of any kind on the product.
10. To reduce the risk of electric shock, do not disassemble this product, but take it to an authorized service facility. Opening or removing cabinet parts other than specified access doors may expose you to dangerous voltage or other risks. Incorrect reassembling can cause electric shock when the appliance is subsequently used.
11. Do not overload wall outlets and extension cords as this can result in the risk of fire or electric shock.
12. Unplug this product from the wall outlet and refer servicing to an authorized service facility under the following conditions:
  - A. When the power supply cord or plug is damaged or frayed.
  - B. If liquid has been spilled into the product.
  - C. If the product has been exposed to rain or water.

## IMPORTANT SAFETY INSTRUCTIONS

- D. If the product does not operate normally by following the operating instructions. Adjust only those controls that are covered by the operating instructions, because improper adjustment of other controls may result in damage and will often require extensive work by an authorized technician to restore the product to normal operation.
- E. If the product has been dropped and the cabinet has been damaged.
- F. If the product exhibits a distinct change in performance.
13. Avoid using a telephone (other than a cordless type) during an electrical storm. There may be a remote risk of electric shock from lightning.
14. Do not use the telephone to report a gas leak in the vicinity of the leak.

**SAVE THESE INSTRUCTIONS**

# INSTALLING THE BATTERY PACK

The Handset of your **SBC9030** is powered by a rechargeable battery pack. It charges automatically whenever the Handset is in the Base Unit. You should charge the battery pack for 16 hours when you first receive your phone. You'll know the battery pack needs charging when:

- The low battery message is displayed:

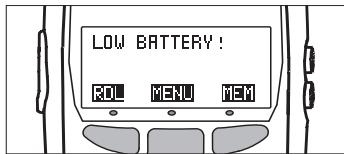

- The Handset seems completely dead, the LCD is completely clear and does not activate when you press the keys.

---

## TO CHARGE THE BATTERY PACK

---

To charge the battery pack, place the Handset in the Base Unit. The CHARGING indicator will light to show the Handset is seated properly and the battery pack is charging. It is recommended that the battery pack be charged for at least 16 hours initially. Afterwards, 8 hours of maintenance charging should be sufficient. You can use your telephone before that with diminished capacity, but it is best to charge the battery pack fully. It will take several recharge cycles to maximize the charge capacity of your battery pack. The maximum battery life between charges is 7 hours of continuous talk time or 14 days of stand by.

Alternatively, if a spare battery pack has been charging in the Base Unit, simply exchange the drained Handset battery pack with the fully charged replacement battery pack from the Base Unit charger. Place the drained Handset battery pack into the Base Unit charger so that it will charge.

The Base Unit spare battery charger does NOT charge a battery pack as quickly as the main Handset battery charger. A full charge requires 24 hours.

---

## A WORD ABOUT RECHARGEABLE BATTERIES

---

Your Ni-Cd battery pack recharges whenever the Handset is returned to the Base Unit.

---

## IT'S IMPOSSIBLE TO OVERCHARGE THE BATTERY PACK

---

The battery pack can be recharged many times but if you get a low-battery signal even after 8 hours of charging in the Base Unit cradle (or 24 hours in the Base Unit spare battery charger), the battery pack(s) should be replaced.

**To purchase replacement battery packs, call Customer Service at 800-667-2118.**



# INSTALLING THE BATTERY PACK

## REPLACING THE HANDSET BATTERY PACK

Follow the steps below:

1. Remove the battery case cover by pressing on the ridged lines and sliding downward.

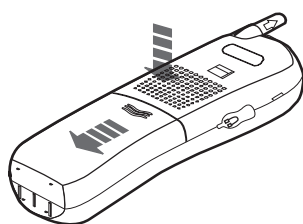

2. Discard the old battery pack. Don't put the old battery pack in a trash compactor or a fire - it could burst. Please recycle.
3. Place the new battery pack in its housing with the metal contacts facing down.

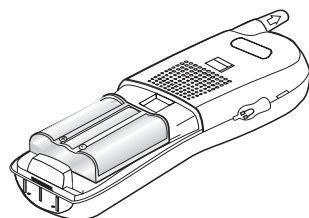

4. Replace the battery case cover by sliding the cover upwards.
5. If the new battery pack is not already charged, place the Handset in the cradle of the Base Unit to allow it to charge for 16 hours.

**CAUTION: To Reduce the Risk of Fire or Injury, Read and Follow the Instructions**

1. Use only Cincinnati Bell rechargeable battery pack, or equivalent.
2. Do not dispose of the battery pack in a fire. The cell may explode.

**IMPORTANT:** Do not dispose of this battery pack into household garbage. For information on recycling or proper disposal, consult your local solid waste collection or disposal organization.

3. Do not open or mutilate the battery pack. Released electrolyte is corrosive and may cause damage to the eyes or skin. It may be toxic if swallowed.
4. Exercise care in handling batteries in order not to short the battery with conducting materials such as rings, bracelets, and keys. The battery pack or conductor may overheat and cause burns.

**To purchase replacement battery packs, call Customer Service at 800-667-2118.**

## SPARE BATTERY CHARGER/ POWER BACKUP FUNCTION

When an optional, Spare Battery pack is installed in the Base Unit, the **SBC9030** uses this battery to provide operational backup in case of a power failure. If you have a fully charged battery pack in the Spare Battery charger and there is a power outage, you will still be able to place and receive calls on the **SBC9030** Handset for up to 4 hours.

The Spare Battery pack can also be used to replace a drained Handset battery to ensure uninterrupted use. Be sure to put the drained battery pack in the Spare Battery charger.

# GETTING STARTED

---

## SETTING UP AC POWER ADAPTER

---

Plug the AC power adaptor into an electrical outlet and the DC connector to the back of the Base Unit.

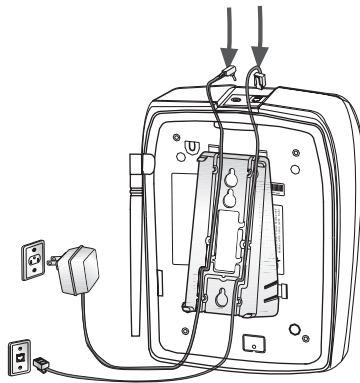

---

**⚠ CAUTION: USE CLASS 2, 9V DC POWER SUPPLY ONLY.**

---

---

## SETTING RINGER

---

The Handset ringer is programmed ON as the factory default setting. To change ringer settings, see **RINGER TONE / VOLUME**.

The Base Unit ringer is controlled independently, by a switch located on the front, right hand side (antenna side) of the Base.

The Base ringer has 3 settings; high, low and off.

---

## TONE/PULSE SELECTION

---

Your **SBC9030** is preset for **Tone** dialing. If you have rotary (pulse) service, program the Handset accordingly. See **SET TONE/PULSE** for details.

---

## CHARGE THE HANDSET BATTERY PACK BEFORE USE.

---

The battery pack recharges automatically whenever the Handset is in the Base Unit. The battery pack must be charged for 16 hours before using your phone for the first time.

---

## CONNECT THE TELEPHONE LINE CORD

---

Plug one end of the telephone line cord into the jack on the back of the Base Unit, plug the other end of this cord into the wall jack.

---

## CHECK FOR A DIAL TONE

---

After the battery is charged, rotate the Base Unit antenna to upright position. Now press **PHONE** on the Handset. **PHONE ON** will appear on the LCD, and you will hear a dial tone. If not, see **IN CASE OF DIFFICULTY**.

Fill in the telephone number card on the Base Unit.

### CAUTION:

1. Never install telephone wiring during a lightning storm.
2. Never install telephone jacks in wet locations unless the jack is specifically designed for wet locations.
3. Never touch uninsulated telephone wires or terminals unless the telephone line has been disconnected at the network interface.
4. Use caution when installing or modifying telephone lines.

# WALL MOUNTING

## USING THE WALL MOUNT ADAPTOR

**1. Position the wall mount bracket on the Base Unit.**

Line up the tabs on the wall mount adaptor with the holes on the bottom of the Base Unit. Snap the wall mount bracket firmly in place.

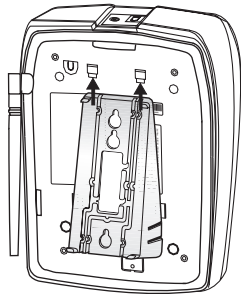

**2. Mount the Base Unit on the wall.**

Position the Base Unit so the mounting studs will fit into the holes on the bottom of the Base Unit. Position the power cord to extend down the wall the phone is to be mounted on. Slide the Base Unit down on the mounting studs until it locks into place.

**3. Plug in the AC adaptor.**

Plug the AC adaptor into an electrical outlet, and the DC connector to the back of the Base Unit. If the Handset battery pack has not been charged previously, place the Handset in the Base Unit cradle, and allow it to charge for **16 hours**.

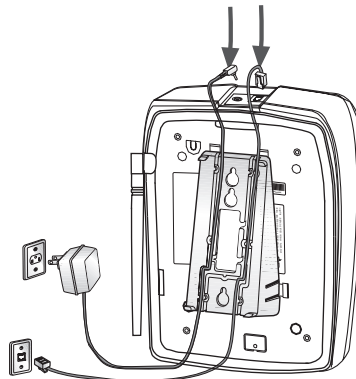

**4. Connect the telephone line cord.**

The telephone line cord has a snap-in plug at each end. Insert one of the plugs into the jack on the bottom of the Base Unit. Insert the other end of the plug into the wall jack.

# HANDSET LAYOUT

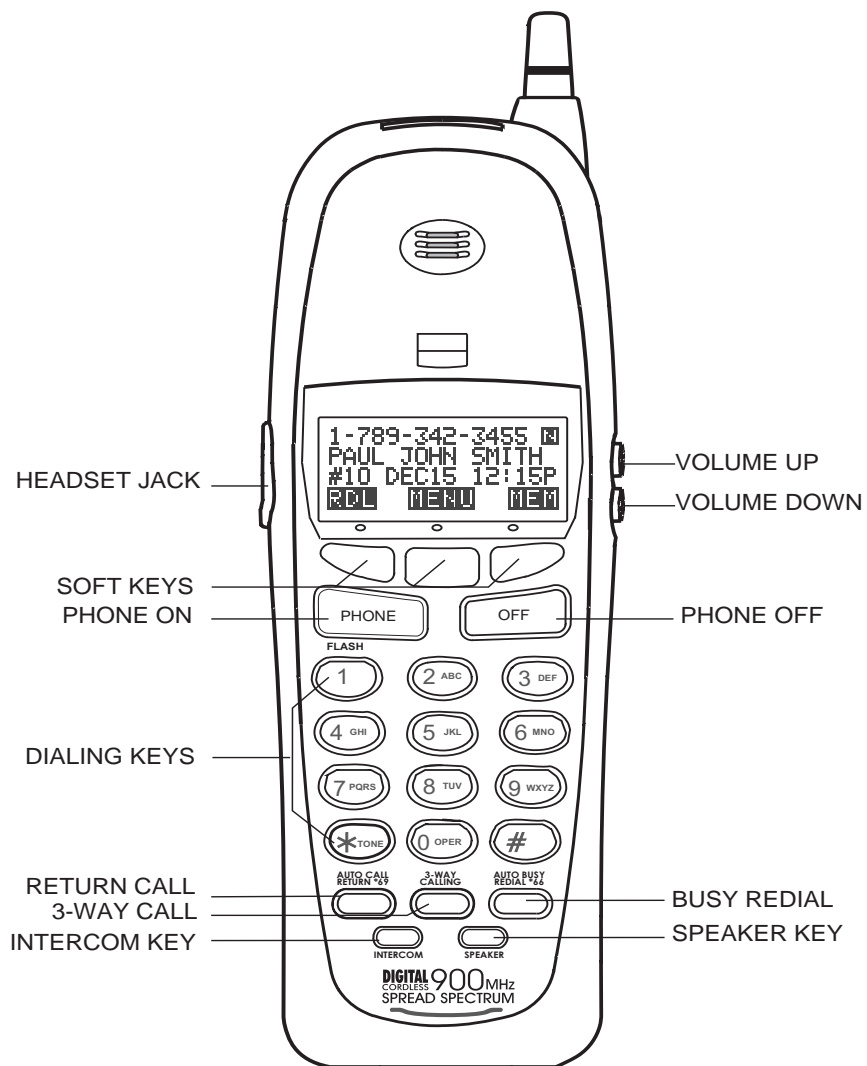

# BASE LAYOUT

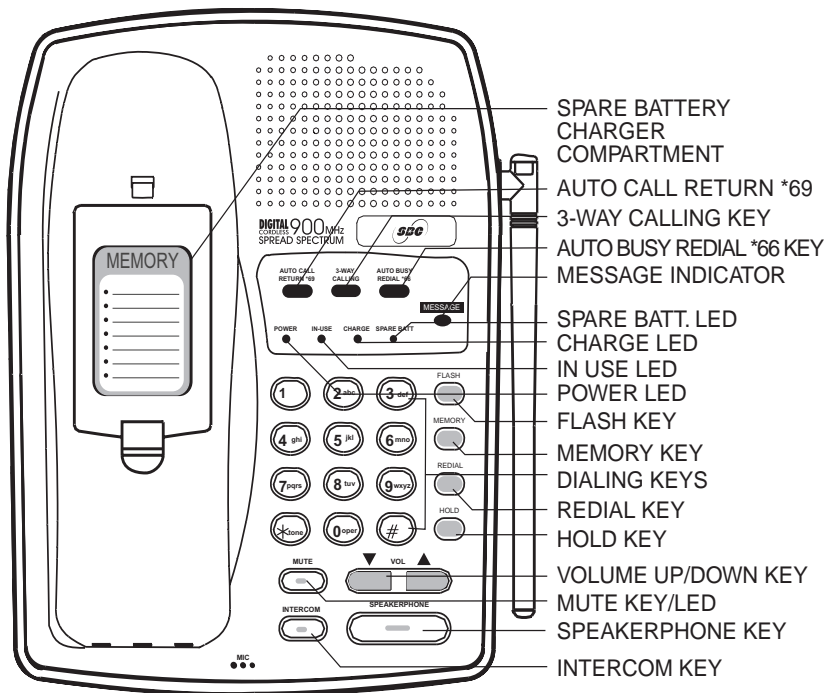
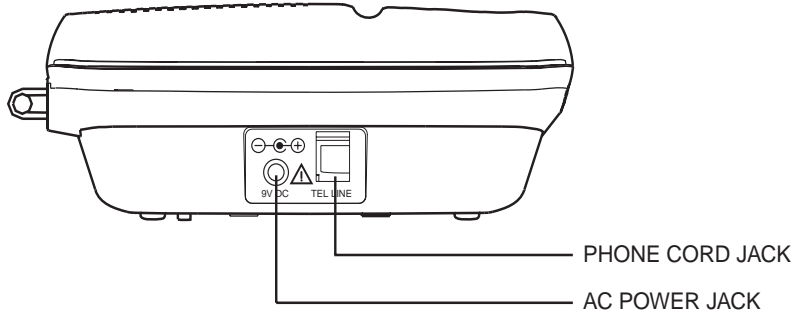

## QUICK REFERENCE GUIDE

Here is a brief guide to the features and functions of your **SBC9030** cordless telephone:

### SET-UP

- Plug AC adaptor into a standard electrical outlet.
- Let Handset battery pack charge for 16 hours before first use.
- Set Dial Mode setting in MENU to PULSE or TONE. The unit is factory set to TONE.
- Connect telephone line cord to Base Unit and telephone jack.

### SETTING TIME

With the Handset in the idle (off) mode:

- Press **MENU**

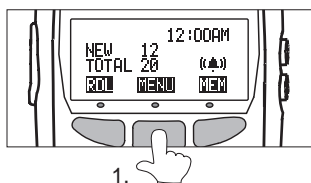

- Use the ▲ / ▼ soft keys to scroll until **5. Set Time** is highlighted
- Press **ENTER**



- Enter the current **hour**. A single-digit hour must be preceded by a **0**.
- Next, enter the **minute**.
- Next, select the **Hour Presentation** (12-hour or 24-hour format) by pressing the key directly below the **12** or **24** icon in the handset display.
- Press **SAVE**. The display will confirm that the time has been updated.



- The time setting will also automatically be updated when Time/Date information is received from Caller ID.

### MAKING CALLS

#### FROM THE HANDSET

- Press **PHONE**. The Handset will briefly display **CONNECTING**, then **PHONE ON**. Listen for dial tone. Using the keypad, dial the desired number. To end your call, press **OFF**, or return the handset to the base unit.

-OR-

- First, dial the desired number. Then, press **PHONE**. After accessing dial tone, the phone number will be dialed. To end your call, press **OFF**, or return the handset to the base unit.

# QUICK REFERENCE GUIDE

## FROM THE BASE

- Press **SPEAKERPHONE**, then wait for dial tone. Dial the desired phone number.
- To end your call, press **SPEAKERPHONE** again.

---

## ANSWERING CALLS

---

- When there is an incoming phone call, pressing **OFF** key on the handset can stop the ringing. You can also answer the call simply by pressing any key except **OFF**, **VOLUME**, **INTERCOM** and the 3 PPU keys.

## FROM THE HANDSET:

- Press any key except **OFF**, **Volume**, **INTERCOM** and the 3 PPU keys.
- Press **OFF** to end your call.

## FROM THE BASE:

- Press **SPEAKERPHONE**. To end your call, press **SPEAKERPHONE** again.

---

## TEMPORARY TONE

---

- If your local telephone service requires rotary (**PULSE**) dialing, you can temporarily switch to **TONE** dialing for such purposes as accessing answering machines, bank-by-phone services, and using calling cards.
- To switch from rotary to tone dialing during a call, press the **\*TONE** key.

When you end your call by pressing **OFF** or returning the handset to the base unit, the phone will return to the rotary (**PULSE**) mode.

---

## VOLUME CONTROL

---

### FROM THE HANDSET

- The phone must be **ON**.



- Located on the side of the Handset, press the **VOLUME UP** or **VOLUME DOWN** keys to raise or lower the earpiece volume. There are **8** volume levels.

### FROM THE BASE

- The Base Unit has its own volume control. The **VOL** Up and Down keys are located directly above the **SPEAKERPHONE** key.

---

## RINGER CONTROL

---

### FROM THE HANDSET

With the Handset in the idle (**off**) mode:

- Press **MENU**

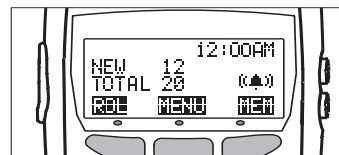

- Using the **▲/▼** soft keys, scroll until **3. Ringer Tone/Vol** is highlighted.

## QUICK REFERENCE GUIDE

- Press **ENTER**
- Use the **RING** soft key to select the Ringer Type (there are 4 ring styles) and **Vol** soft key to select the ringer volume (High, Low or Off).

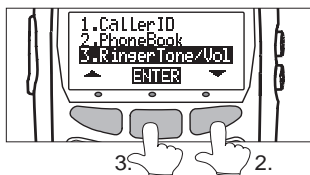

- Press **SAVE** to store your ringer settings

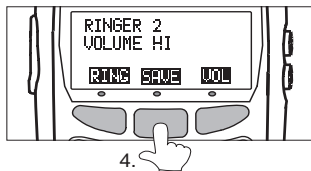

- To exit programming mode at any time, press **OFF** key .

### FROM THE BASE

- The Base Unit ringer is controlled independently, by a switch located on the front, right hand side (antenna side) of the Base.
- The Base ringer has (3) settings: High, Low and Off.

---

### HOLD

---

#### FROM THE HANDSET

- Press the **HOLD** soft key to place an active call on hold. Press the **TALK** soft key or the **PHONE** key to return to your call.
- If an extension phone is activated while the **SBC9030** has a call on **HOLD**, the **SBC9030** will release the call and turn itself OFF.

#### FROM THE BASE

- During a Speakerphone call, press **HOLD** on the Base Unit. The red light (LED) built into the **SPEAKERPHONE** key, will flash rapidly while your call is on hold.
- Press either **HOLD** or **SPEAKERPHONE** to return to your call.

---

### MUTE

---

#### FROM THE HANDSET

- Press the **MUTE** soft key to disable the Handset microphone during an active call. Press the **TALK** soft key to return to normal 2-way conversation.



#### FROM THE BASE

- During a Speakerphone call, press **MUTE** to disable the Base Unit microphone. The red light (LED) built into the **MUTE** key, will glow.
- Press **MUTE** again to return to a two-way conversation.

---

### REDIAL WITH THE HANDSET ON (OFF HOOK)

---

- Press the **RDL** soft key to display the last three telephone numbers you dialed.



## QUICK REFERENCE GUIDE

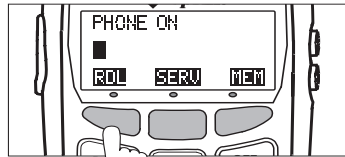

1.

- Using the ▲ / ▼ soft keys, select the number from the list and then press **DIAL** soft key.

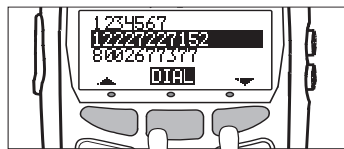

3. 2.

### REDIAL WITH THE HANDSET OFF (ON HOOK)

- Press **RDL**. The Handset will display last 3 phone numbers dialed.

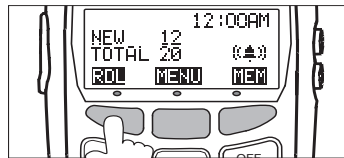

1.

- Use the ▲ / ▼ soft keys to highlight the desired phone number.
- Press **PHONE**. The **SBC9030** will access dial tone, and dial the number.

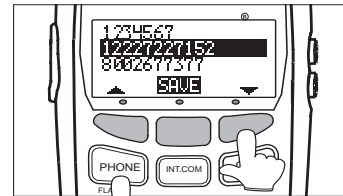

3. 2.

### PAGE/HANDSET LOCATOR

- To page the Handset from the Base Unit, press **INTERCOM**. The Handset will emit a special beep tone for up to 60 seconds, In addition, the Handset will display **BASE PAGING**.
- To answer the page, press **INTERCOM** on the Handset. You are now in intercom mode.
- To terminate the page, press **OFF** on the Handset, or **INTERCOM** on the Base Unit.

### INTERCOM BETWEEN HANDSET AND BASE

#### FROM THE HANDSET (when HANDSET OFF or ON HOOK)

- Press the **INTERCOM** key. The Base Unit will emit 2 short tones and then enter Intercom mode. You can now talk to the person at the Base Unit.
- The Handset will display as:



## QUICK REFERENCE GUIDE

- Press the **MUTE** softkey to mute the handset microphone. But you can still hear the speaking from the Base.
- You can return the intercom conversation with the Base by press the **TALK** softkey.
- Press the **OFF** key to end the intercom mode.

### FROM THE HANDSET (with HANDSET ON or OFF HOOK)

- You can use the intercom when you are in a call.
- Press the **INTERCOM** key, then you can talk to the Base unit.
- At the same time, your active call will be placed on **HOLD**.



- You can press the **MUTE** softkey to mute the handset microphone. But you can still hear the speaking from the Base.
- You can return the intercom conversation with the Base by pressing the **TALK** soft key.
- Press the **OFF** key to end the intercom mode. But, at this time, your call still on hold. You need to press the **TALK** softkey or the **PHONE** key to return to your call.
- Anytime in the intercom mode, you can press the **PHONE** key to end the intercom and return to your call.

### FROM THE BASE (with SPEAKERPHONE OFF)

- Press **INTERCOM** key to page the Handset.
- After the Handset receives the page from the Base, press the **INTERCOM** key on the Handset to establish conversation.
- During the intercom, you can press the **MUTE** key to mute the microphone on the Base. But you can still hear the speaking from the Handset.
- Press the **MUTE** key once again to release the mute function.
- Press **INTERCOM** key to exit the intercom mode.

### FROM THE BASE (with SPEAKERPHONE ON)

- You can use intercom during a call
- Press **INTERCOM** key to page the Handset. You will be on hold.
- After the Handset receives the page from the Base, press the **INTERCOM** key on the Handset to establish conversation.
- During the intercom, you can press the **MUTE** key to mute the microphone on the Base. But you can still hear the speaking from the Handset.
- Press the **MUTE** key once again to release the mute function.
- Press **INTERCOM** and then **SPEAKERPHONE** key to exit the intercom mode and return to the call.
- Or simply press **SPEAKERPHONE** to exit the intercom mode and return to the call.

# QUICK REFERENCE GUIDE

## CONFERENCE

Your **SBC9030** allows you to establish a 3 party conference between the Handset, Base and the incoming call:

- 1) Use either the Base or the Handset to make a call.
- 2) If you are using the Base to make the call, the Handset can join the conference by pressing **PHONE**. Or, press the **SPEAKERPHONE** key on the Base if you use the Handset to make the call.



- 3) If either the Handset or the Base parties want to leave the conference, either side can press **OFF** (on the Handset) or **SPEAKERPHONE** (on the Base) to leave.

## REVIEWING CALLER ID RECORDS

**NOTE:** Caller ID and Call Waiting ID are subscription services, available through most local telephone service providers. These are optional services; you are not required to subscribe to them. However, to receive Caller ID on your **SBC9030**, subscription through your local phone company is required.

With the Handset in the **OFF** (on hook) mode:

- Press **MENU**

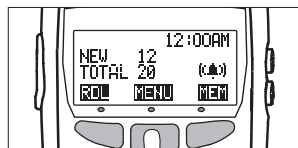

1.

- Using the **▲ / ▼** soft keys scroll until **1. Caller ID** is highlighted
- Press the **ENTER** soft key.

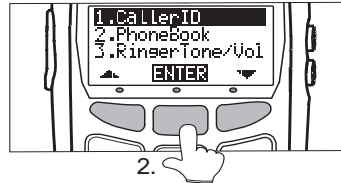

2.

- Use the **▲ / ▼** soft keys to scroll through the Caller ID records. The **SBC9030** will store the last **50** Caller ID records to come in. The latest one will be in #01.
- Press **OFF** to exit Caller ID mode.

## MEMORY DIALING

### FROM THE HANDSET

With the Handset **OFF** (on hook):

- Press the **MEM** soft key.

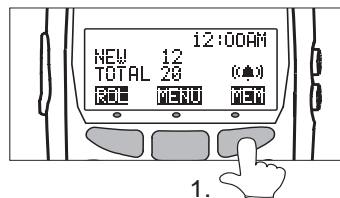

1.

- Enter Memory Location (01-25). As soon as you enter the second digit, the contents of the selected Memory Location will be displayed.



- Press **PHONE** key or the **DIAL** soft key to dial the displayed phone number.

# QUICK REFERENCE GUIDE



With the Handset **ON** (off hook):

- Press **PHONE**. Listen for dial tone.

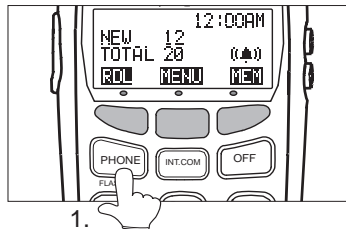

- Press the **MEM** soft key.

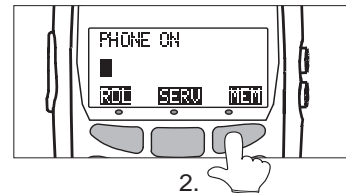

- Enter Memory Location (01-25).
- Press the **PHONE** or **DIAL** key.



## FROM THE BASE

- Press **SPEAKERPHONE** to get the dial tone.
- Press **MEMORY** key, then enter 2 digit location number (01-25).

- You will then hear the dialing sequence.

---

## FLASH

---

- You can use your **SBC9030** with services such as Call Waiting. Simply press the **PHONE** key to flash the line on the Handset, OR press **FLASH** on the Base.

---

## HANDSET SPEAKERPHONE FEATURE

---

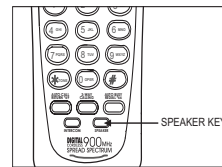

Press the **SPEAKER** to make or answer a call using the Handset Speakerphone. The Handset displays **HS SPEAKER**. You can now talk hands-free away from the Base Unit. Press **OFF** to end a call.

**Call Waiting:** If you hear a Call Waiting tone during a speakerphone call, press the **SPEAKER** key to answer it. (Do not use the **PHONE** key to answer Call Waiting while using the speakerphone.)

**Switching from Speakerphone to Earpiece:** At any time during a Handset speaker call, you can press **PHONE** to switch to a non-speaker call. The Handset will display **PHONE ON**, and you can hold the handset to your ear normally. Press **Speaker** whenever you want to change back to the Speakerphone. The Handset will display **HS SPEAKER**.

# SOFT MENU FUNCTIONS

The **SBC9030** has an advanced design which uses a menu system and soft keys to access all of the built in features.

Example of the idle mode display:

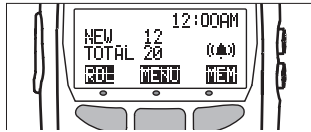

**NEW:** The number of Caller ID records not previously viewed  
**TOTAL:** The total number of stored Caller ID records (50 max.)

## RDL (Redial)

Press **RDL** to display the last **3** telephone numbers dialed. The number on the top line is the most recent number dialed. The display will look like:



- Use the ▲/▼ soft keys to select desired number.
- Once highlighted, press **PHONE** to dial.
- To save the phone number in the phone book directory, press **SAVE**. The LCD will display:



- Press **PSE** if you want to add a 2 second pause in the dialing sequence.

- Press **CLR** to backspace
- Press **SAVE** to save the phone number in the Phone Book directory. The LCD will display:



- Using the keypad, enter the desired name (15 character maximum)
- Press → to advance the cursor to the next space. You won't have to advance the cursor if the next letter of the name is not on the same key as the previous letter; it will advance automatically.
- Press **CLR** to backspace
- Press **SAVE** when you finished entering the desired name. The LCD will display:



- The XX location displayed is the smallest, unoccupied directory location. If you want to save the phone number in a different location, press **CLR**, and then enter the two digit directory location you desire (01-25).
- Press **SAVE** to confirm your location selection. The screen will display:



# SOFT MENU FUNCTIONS

Then the display shows:



You can record your voice saying the person's name. If you subscribe to Caller ID, the phone will play your recording when this person calls, so that you can hear who's calling without seeing the Caller ID display.

If you do not want to record a name:

- Press **NO**.

To record a name:

- Press **YES** and speak after the beep.
- You can press **#** when you're finished speaking, OR just wait-recording ends after 4 seconds.

The Handset shows:



To hear your recording:

- Press **ENTER** while **1. Play Back VA** is highlighted.

To make a new recording of the name:

- Press **▼** until **2. Redo VA** is highlighted.
- Press **ENTER** and speak after the beep.

You can re-record as many times as you want. Each time you re-record or review the name, the Handset shows:



When you are satisfied with your recording:

- Press **EXIT**.

---

## MEM (Memory)

---

From the idle mode display, press **MEM**, the screen will now display:



Enter the 2-digit location code representing the Phone Book directory record you wish to access. The screen will display the contents of that record. If the contents of the selected record are empty, the screen will display:



and then ask for another 2-digit location code.



With the contents of the Phone Book record displayed, press:

- **DIAL** to access the line and dial the displayed phone number,
- **CLR** to clear the display and allow you to enter another location number,
- **EXIT** to exit Memory Dialing, and return to the idle mode display.

# SOFT MENU FUNCTIONS

You can also access directory records by entering the **name** of the desired party. See **PHONE BOOK** for details.

## MENU

With the Handset in the idle (OFF) mode, press the **MENU** key to access the following options:

1. **Caller ID**
2. **Phone Book**
3. **Ringer Tone/Vol**
4. **KeyBeep On/Off**
5. **Set Time**
6. **Clear ALL MEM**
7. **AutoAns (Auto Answer) On/Off**
8. **Set Tone/Pulse**
9. **Del (delete) MSG Icon.**
- \*. **Voice Announce.**

Use the **▲/▼** keys to select the desired option, then press **ENTER**.

Because there are only three lines to display information, only three of the menu options will be displayed at a time. The first screen displayed is:

1. **Caller ID**
2. **Phone Book**
3. **Ringer Tone/Vol**

The second screen is:

4. **KeyBeep On/Off**
5. **Set Time**
6. **Clear ALL MEM**

The third screen is:

7. **AutoAns (Auto Answer) On/Off**
8. **Set Tone/Pulse**
9. **Del (delete) MSG Icon**

And the fourth screen is:

- \*. **Voice Announce**

The following sections detail how to access and operate the ten **MENU** functions.

**Note:** You do not have to use the **▲/▼** soft keys to select menu options. Instead, you can simply press the number key that corresponds to the desired feature.

For an example, if you want to access the **Set Time** function, using the **▲/▼** soft keys you would do the following:

- Press **MENU**

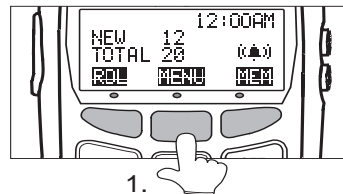

1.

- Using the **▲/▼** keys, scroll until **5. Set Time** is highlighted
- Press **ENTER**



3. 2.

- Then follow the on-screen prompts  
However, using the shortcut, all you would need to do is:

- Press **MENU**
- Press the **5** key to enter the **Set Time** function

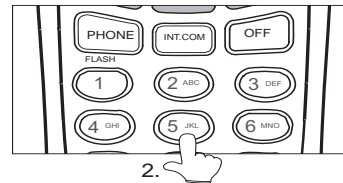

2.

- Then follow the on-screen prompts.

# CALLER ID

Once you have chosen **CALLER ID** (Menu selection #1), the screen will display:

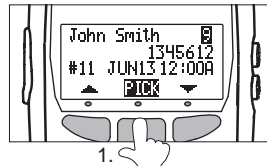

- If an **N** in a shaded box appears in the upper right hand corner of the Caller ID screen, this indicates that it is a new(not previously viewed) record. If a **number** in a shaded box appears in the upper right hand corner of the Caller ID screen, this indicates that you have received multiple calls from this party. For example, a **3** indicates that the party has called 3 additional times since the initial call. This repeat indicator can go to a maximum of 9.
- Use the ▲/▼ keys to scroll through the records.
- Once you have found the desired record, press **PICK**.

You now have **3** options:

- **SAVE** the phone number (and name) in the Phone Book directory,
- **DIAL** the phone number, or
- **DEL** (delete) the Caller ID record from memory.

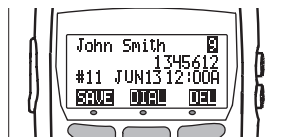

## SAVE

Press **SAVE** while reviewing a Caller ID record. The screen will display:



- Press **PSE** if you want to add a 2 second pause in the dialing sequence
- Press **CLR** to backspace
- Press **SAVE** to save the phone number in the Phone Book directory. The LCD will display:



- Press → to advance the cursor to the next space. You won't have to advance the cursor if the next letter of the name is not on the same key as the previous letter; it will advance automatically.
- Press **CLR** to backspace
- Press **SAVE** when you finish entering the desired name. The LCD will display:

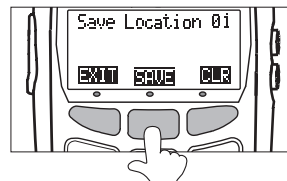

- If you want to save the phone number in a different location, press **CLR**, and then enter the two-digit directory location you desire (01-25).
- Press **SAVE**. The screen will confirm your location selection. Then the display shows:



You can record your voice saying the person's name. If you subscribe to Caller ID, the phone will play your recording when this person calls, so that you can hear who's calling without seeing the Caller ID display.



# CALLER ID

If you do not want to record a name:

- Press **NO**.
- To record a name:
- Press **YES** and speak after the beep.
  - You can press **#** when you're finished speaking, OR just wait-recording ends after 4 seconds.

The Handset shows:



To hear your recording:

- Press **ENTER** while **1. Play Back VA** is highlighted.

To make a new recording of the name:

- Press **▼** until **2. Redo VA** is highlighted.
- Press **ENTER** and speak after the beep.

You can re-record as many times as you want. Each time you re-record or review the name, the Handset shows:



When you are satisfied with your recording:

- Press **EXIT**.

**NOTE:** To cancel the operation, press **EXIT** to return to the idle mode display at any time. The screen will display:

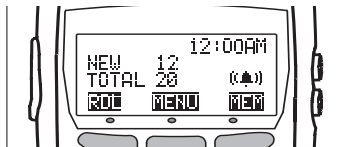

## DIAL

Press **DIAL** or **PHONE** when reviewing a Caller ID record. The screen will display up to 4 dialing options: (examples)

**1. 643-8981**  
Local# only (7 digits)

**2. 1-503-643-8981**  
Long Distance (11 digits)

**3. 503-643-8981**  
Area Code+ local# (10 digits)

**4. 1-643-8981**  
"Local" Long distance (8 digits)

- To dial, use the **▲/▼** scroll keys to select the desired dialing option, then press **DIAL** or **PHONE**;

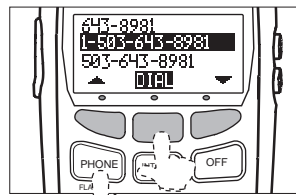

1.  or.

- OR -

- Enter the desired number key, 1 through 4. The **SBC9030** will access dial tone, and dial the selected sequence.

## DEL (Delete)

Press **DEL** while reviewing a Caller ID record. The screen will display:

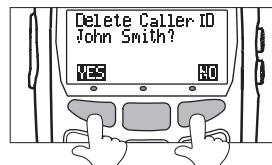

# CALLER ID

- Press **YES** to delete the displayed Caller ID record. The screen will say:



- Press **NO** to cancel the deletion, and return to the main display.

---

## CALLER ID - CALL WAITING ID

---

Your **SBC9030** is capable of displaying the **name** and/or **number** of the party calling before you answer the phone (**Caller ID**). It is also capable of displaying Caller ID information in conjunction with a Call Waiting alert signal (**Call Waiting ID**). With Call Waiting ID, the Caller ID data will help you decide whether to switch to the incoming call, or continue with your current conversation.

---

## NOTES ABOUT CALLER ID & CALL WAITING ID

---

These are subscription services, provided by most regional telephone service providers. You must subscribe to these services to get the benefits of these features. If you do not subscribe to Caller ID services, you can still use your **SBC9030** and the other features it offers.

Due to regional incompatibilities, Caller ID information may not be available for every call you receive. In addition, the calling party may block their name and phone number from being sent.

---

## VOICE ANNOUNCE CALLER ID

---

If you subscribe to Caller ID, the unit can be programmed to announce the caller's name or number from the Base

Unit speaker, while displaying the Caller ID information on the Handset.

If you want the phone to announce names, you must record a name with the numbers in your Phone Book. See the section "**PHONE BOOK: ADDING NEW PHONE BOOK RECORDS AND VOICE ANNOUNCE RECORDS**".

When you first receive the phone, Voice announce is default set to ON. It will announce the caller's name if you have recorded it, or the phone number if you haven't recorded a name.

If an inbound call has the Caller ID information blocked, the Base Unit will announce "**PRIVATE CALLER**".

If the Caller ID information unavailable (both name and number), the Base Unit will announce "**UNKNOWN CALLER**".

You can choose to turn off Voice Announce, or to announce only your pre-recorded names. The Handset will still display all Caller ID information.

To turn Voice Announce **ON** or **OFF**:

- Press **MENU**.
- Using the **▲/▼** keys, scroll until **\* Voice Announce** is highlighted.
- Press **ENTER**, you will see three announcement options:

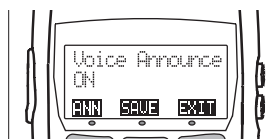

**ON:** Announce names that you have recorded, and phone numbers for all other callers.

**NAMES ONLY:** Announce names that you have recorded. If you have not recorded a caller's name, you will not hear anything.

**OFF:** Nothing is announced aloud.

- Press **ANN** until the desired option is displayed.
- Press **SAVE**, the Handset will beep.

# PHONE BOOK

The names and phone numbers of **25** frequently called parties can be stored in the **SBC9030** Phone Book directory. You will find instructions for programming names and numbers into the directory in the section, **ADDING NEW PHONE BOOK RECORDS**.

Once you have chosen **PHONE BOOK** (Menu selection **#2**), the screen will display:



Using the numeric keys, enter the first letter of the desired name. The Handset will display either the exact record, or a close match. If it is not the desired record, press the **▲/▼** scroll keys to search.

If the phone book record is saved with Voice Announce Recording, an icon  will be displayed at the top right corner.



Once you are viewing the desired record, press **PICK**. You now have the following options:

- **EDIT** – if you want to change the name or phone number
- **DIAL** – to access the line and dial the phone number
- **DEL** - to delete the record from the directory. You will then be prompted to press **YES** to confirm deletion or **NO** to cancel and return to the idle mode display.

## EDITING PHONE BOOK RECORDS & VOICE ANNOUNCE RECORDS

If you press **EDIT**, the Handset will display:



- Press **PSE** if you want to add a 2-second pause in the dialing sequence
- Press **CLR** to backspace
- Press **SAVE** to save the phone number in the Phone Book directory. The LCD will display:



- Press **→** to advance the cursor to the next space. You won't have to advance the cursor if the next letter of the name is not on the same key as the previous letter; it will advance automatically.
- Press **CLR** to backspace
- Press **SAVE** when you finish entering the desired name. The LCD will display:



The **XX** location displayed is its original location.

If you want to save the phone number in a different location, press **CLR**, and then enter the two-digit location number.

Press **SAVE** to confirm your location selection. The screen will display:

# PHONE BOOK



If you are saving an edited record in its original directory location, you will see the following message after pressing **SAVE**:

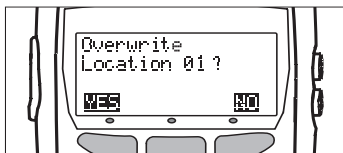

If you press **NO**, the Handset will return to:



You can choose a new location, or press **EXIT** to return to the idle mode display.

If you press **YES**, the Handset will display:



If the phone book record has a Voice Announce Recording, after you have saved the edited record, the LCD will display :



You can playback, redo or erase the recording by selecting from the above menu. For detail operation, please see page 29.

For a phone book record without a Voice Announce Recording, the Handset will prompt you:



Press **YES** if you want to record a name or **NO** if you do not.

## ADDING NEW PHONE BOOK RECORDS & VOICE ANNOUNCE RECORDS

Starting from the idle mode (off) display, enter the number you want to store in the Phone Book directory. Then:

- To save the phone number in the phone book directory, press **SAVE**. The LCD will display:



- Press **PSE** if you want to add a 2-second pause in the dialing sequence
- Press **CLR** to backspace
- Press **SAVE** to save the phone number in the Phone Book directory. The LCD will display:



Each of the number keys has a specific set of characters. Each press of a particular number key causes characters to be displayed in the following order:

# PHONE BOOK

Number Key    Characters (in order)

1.....	& ' , . 1
2.....	A B C 2
3.....	D E F 3
4.....	G H I 4
5.....	J K L 5
6.....	M N O 6
7.....	P Q R S 7
8.....	T U V 8
9.....	W X Y Z 9
0.....	0

- Press **➡** to advance the cursor to the next space. You won't have to advance the cursor if the next letter of the name is not on the same key as the previous letter; it will advance automatically.
- Press **CLR** to backspace
- Press **SAVE** when you're finished entering the desired name. The LCD will display:



- The XX location displayed is the smallest, unoccupied directory location. If you want to save the phone number in a different location, press **CLR**, and then enter the two digit directory location you desire (01-25).
- Press **SAVE** to confirm your location selection. The screen will display:



Then the display shows:



In your own Voice you can record the person's name associated with this record. If you subscribe to Caller ID, the phone will play your recording when this person calls, so that you can hear who's calling without seeing the Caller ID display.

If you do not want to record a name:

- Press **NO**.
- To record a name:
- Press **YES** and speak after the beep.
  - You can press **#** when you're finished speaking, OR just wait-recording ends after 4 seconds.

The Handset shows:



To hear your recording:

- Press **ENTER** while **1. Play Back VA** is highlighted.

To make a new recording of the name:

- Press **▼** until **2.Redo VA** is highlighted.
- Press **ENTER** and speak after the beep.

You can re-record as many times as you want. Each time you re-record or review the name, the Handset shows:



When you are satisfied with your recording:

- Press **EXIT**.

To erase the recording,

- Press **ENTER** while **3. Erase VA** is highlighted.
- A confirmation tone will be heard.
- Press **EXIT** when you're finished. You will see the **VA** is removed on the Phone Book record.

## OTHER MENU SETTINGS

### RINGER TONE / VOLUME

You can adjust the Handset ringer style and volume level. There are **4** ringer styles and **3** volume levels: **HI**, **LO**, and **OFF**.

Once you have selected **RINGER TONE/VOL** (Menu selection #3), the Handset will display:



To select a ringer style, press the **RING** soft key.

To adjust ringer volume, press the **VOL** soft key.

Press **SAVE** to confirm your selections. The screen will display **Setting Updated**, and return to the idle mode display.

If you select Ringer Volume **HI**, the idle mode screen will display "(📶)".

If you select Ringer Volume **LO**, the idle mode screen will display "(📶)".

If you select Ringer Volume **OFF**, the idle mode screen will display "(📶)".

### KEY BEEP ON/OFF

As you use your **SBC9030**, you will hear a quiet *beep* with each key press. You can turn this feature *off*, if you choose **KEY BEEP** to be OFF.

Once you have selected **KEY BEEP ON/OFF** (Menu selection #4), the Handset will display:



Press **ON** or **OFF**, depending on your preference, then press **SAVE**. The screen will display **Setting Updated**, and return to the idle mode display.

Factory default setting is **Key Beep ON**.

## OTHER MENU SETTINGS

### SET TIME

Once you have selected **SET TIME** (Menu selection #5), the Handset will display:



For detail operation, please see "Setting Time" on Page 14.

After pressing **SAVE** to confirm your selections, the Handset will display **Setting Updated**, and return to the idle mode display.

### CLEAR ALL MEM

This feature allows you to erase the entire contents of the **PHONE BOOK** and/or **CALLER ID** memory.

Once you have chosen **CLEAR ALL MEM**, (Menu selection #6), the Handset will display:

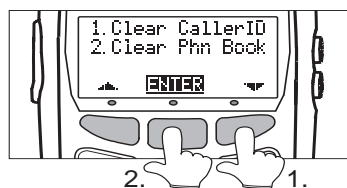

Use the ▲/▼ scroll keys to make your selection, then press **ENTER**.

The screen will ask you to confirm your decision to delete the entire contents of Caller ID or Phone Book memory; for example:



Press **YES** to confirm. The screen will display:



If you change your mind and do not want to delete all records, press **NO**. You will be returned to the idle mode display.

## OTHER MENU SETTINGS

---

### AUTO ANSWER ON/OFF

---

Factory default setting is **Auto Answer OFF**.

With **Auto Answer** set to **OFF**, when the phone is on cradle, you cannot simply pick up the phone to answer incoming call, you must press **PHONE** to answer the call. This allows you to review the Caller ID information before answering. However, if you prefer to have your Handset automatically answer the call when removed from the Base cradle:

Select **AutoAns On/Off** (Menu selection #7). The Handset will display:

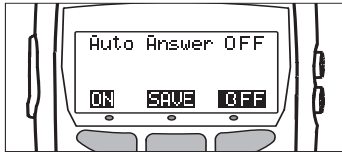

Press **ON** (or **OFF** if you're canceling Auto Answer), then **SAVE**. The screen will display **Setting Updated**, and return to the idle mode display.

---

### SET TONE /PULSE

---

Your **SBC9030** is preset for tone dialing. To change the dialing mode setting, choose **SET TONE/PULSE** (Menu selection #8), the screen will display:



Press **TONE** or **PULSE**, depending on the requirements of your local telephone provider. If you are not sure, contact your local phone company.

Press **SAVE**. The screen will confirm that the dialing mode is updated, and then return to the idle mode display.

---

### DELETE MSG ICON

---

Refer to **MESSAGE WAITING INDICATOR** for explanation of this feature.



# HEADSET OPERATION

Your **SBC9030** is equipped with a 2.5mm Headset Jack for use with an **optional** accessory Headset for hands free operation.

If you choose to use the Headset option, you must obtain an optional accessory Headset, which is compatible with the **SBC9030**.

**To purchase a Headset, call 800-667-2118.**

Once you have a compatible 2.5mm Headset, locate the Headset Jack on the **SBC9030** Handset. Connect the plug on the Headset cord to the jack on the cordless Handset. The plug should fit securely. Do not force the connection.

---

## OPERATION

---

**NOTE:** Whenever a compatible Headset is connected to the cordless Handset, the microphone on the Handset will be muted. This is done to limit the effect of background noise.

The following operational characteristics apply to compatible Headsets. The same may also apply to other headsets, but **SBC** assumes no responsibility for their performance.

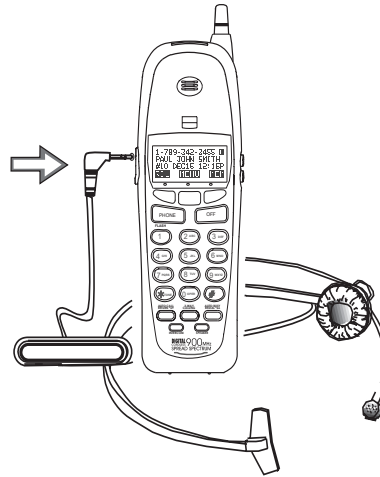

---

## BELT CLIP

---

The **SBC9030** is also equipped with a detachable belt clip. Align the pins on the inside edge of the clip with the notches on the sides of the **SBC9030** Handset. The belt clip should snap securely into place. Do not force the connection.

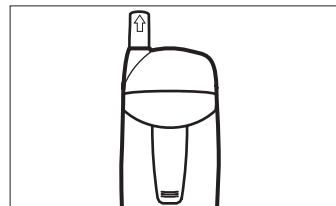

## ADDITIONAL OPERATING TIPS

### OUT OF RANGE INDICATION

When the handset is in **Phone On** mode and moved to a point where it and the Base Unit can no longer communicate, the Handset will beep twice and display **OUT OF RANGE**:

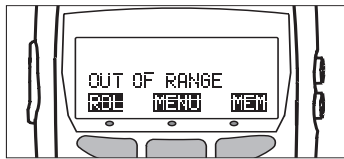

and attempt to re-link with the Base. If this occurs while you're on a call, move closer to the Base Unit.

If the Handset does not re-establish contact with the Base within 30 seconds of losing contact, the Handset will automatically drop the call and turn off.

If you walk out of range while the Handset is not in use, the Handset will beep twice and display **OUT OF RANGE** until the user presses any key.

**NOTE:** If the Base Unit is without power, the Handset will behave as if it is out of range. Therefore, if the handset beeps, the display **OUT OF RANGE** occurs, and moving closer to the Base does not help, check the Base Unit to make sure it has power.

### MESSAGE WAITING INDICATOR (for use with Voicemail)

Your **SBC9030** is capable of detecting a visual Message Waiting signal, generated by many phone service pro-

viders. If you subscribe to Voicemail service from your local telephone company, and a visual message waiting signal is provided, the **SBC9030** will display  on the right side of the Handset LCD to alert you to new, unplayed messages.

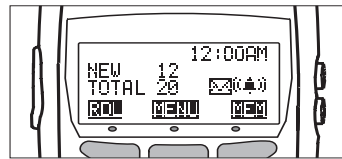

On the Base, the red MESSAGE LED will light up to alert you to new unplayed messages.

Once you have reviewed all of your new voicemail messages and hang up the phone, the **SBC9030** will turn off the Handset and Base indicators automatically. Note that there is a delay for the indicators to turn off, as the **SBC9030** is waiting for an update signal from the telephone network.

After all new voicemail messages have been reviewed, if the MESSAGE WAITING indicator (icon or Base LED) remains on, you can manually clear the indications as follows:

- Press **MENU**, scroll to 9. **Del MSG Icon**. Press **ENTER**

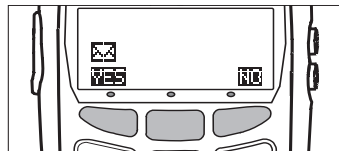

- Press **YES** to turn off the Handset icon and Base LED.

## ADDITIONAL OPERATING TIPS

---

**NOTE: Message Waiting indicator works in conjunction with Voicemail service from many local phone companies. This is an optional service; you are not required to subscribe to it.**

---

---

### CUSTOM PAY-PER-USE (PPU) FEATURES

---

Your **SBC9030** gives you easy access to **5** popular custom features, offered by many telephone companies:

1. **Return Call**
2. **Repeat Dial**
3. **No Call Wait**
4. **Call FWD ON**
5. **Call FWD OFF**

To use a custom Pay-Per-Use feature, do the following:

- Press **PHONE**. Listen for dial tone.
- Press the **SERVE** soft key.
- Using the **▲/▼** soft keys, scroll until the desired custom feature is highlighted.
- Press **ENTER**.

In addition, 3 custom pay-per-use services are accessible using one-touch keys located both the **SBC9030** Handset and Base Unit; Specifically:

#### **AUTO CALL RETURN \*69** **3-WAY CALLING** **AUTO BUSY REDIAL \*66**

**AUTO CALL RETURN \*69** dials the last party who called you, whether or not you answered the call. A charge is added to your phone bill each time you use this feature.

**3-WAY Calling** allows you to talk with 2 separate parties from a single line. The set-up procedure is as follows:

- 1) Call your first party; after the party answers,
- 2) Press **3-WAY Calling**. Wait for dial tone.
- 3) Call your second party; after the call is answered.
- 4) Press **3-WAY Calling** again.

A charge is added to your phone bill each time this service is used.

**AUTO BUSY REDIAL \*66** repeatedly dials the last number you called, over a time interval determined by your local company. This is useful in reaching a party whose line is busy. A charge is added to your phone bill each time this service is used.

**NOTE:** It is likely that your local telephone company will assess charges to use custom features. You should check with your local service provider regarding which custom services are available in your area, and the associated costs for the intentional or unintentional use of Pay Per Use services.

Your local telephone company may provide a monthly subscription to an individual service or a package of services which gives you unlimited usage for a small monthly fee.

## ADDITIONAL OPERATING TIPS

---

### LOW BATTERY INDICATION

---

During a Low Battery condition, the Handset LCD will display:

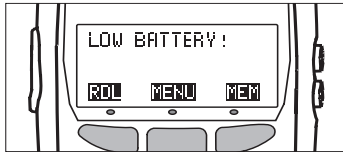

When this occurs, you should either return the Handset to the Base Unit for recharging, or exchange the drained Handset battery with a fully charged battery from the Spare Battery charger.

---

### CHECK AC POWER INDICATION

---

A charged battery installed in the Base Unit will allow you to make and receive calls from the Handset in the event of a power failure, for approximately 4 hours. During power back-up mode, the Handset will display:



If your **SBC9030** displays this message, and AC power is present, check the electrical outlet and the AC adapter, ensuring that it is firmly connected to the outlet and the Base Unit.

# MAINTENANCE

---

## TAKING CARE OF YOUR TELEPHONE.

---

Your **SBC** cordless telephone contains sophisticated electronic parts, so it must be treated with care.

---

## AVOID ROUGH TREATMENT

---

Place the Handset down gently. Save the original packing materials to protect your telephone if you ever need to ship it.

---

## AVOID WATER

---

Your telephone can be damaged if it gets wet. Do not use the Handset outdoors in the rain, or handle it with wet hands. Do not install your Base Unit near a sink, bathtub or shower.

---

## ELECTRICAL STORMS

---

Electrical storms can sometimes cause power surges harmful to electronic equipment.

For your own safety, be cautious when using electrical appliances during storms.

---

## CLEANING YOUR TELEPHONE

---

Your telephone has a durable plastic casing that should retain its luster for many years. Clean it only with a soft cloth slightly dampened with water or a mild soap. Do not use excess water or cleaning solvents of any kind.

---

Remember that electrical appliances can cause serious injury if used when you are wet or standing in water. If your base unit should fall into water, **DO NOT RETRIEVE IT UNTIL YOU UNPLUG THE POWER CORD AND TELEPHONE LINE CORDS FROM THE WALL.** Then pull the unit out by the unplugged cords.

---

## IN CASE OF DIFFICULTY

If you have difficulty operating your phone, the suggestions below should solve the problem. If you still have difficulty after trying these suggestions, call the Customer Service at 800-667-2118.

---

### THE PHONE DOESN'T WORK AT ALL.

---

- Make sure the Power Cord is plugged in.
- Make sure the telephone line cord is plugged firmly into the Base Unit and the telephone wall jack.
- Make sure the battery pack is properly charged. If the "LOW BATTERY" message is shown, the battery pack needs charging.

---

### NO DIAL TONE.

---

- First check all the suggestions above.
- If you still don't hear a dial tone, disconnect the Base Unit from the telephone jack and connect a different phone. If there is no dial tone on that phone either, the problem is in your wiring or local service. Call your local telephone company.

---

### YOU GET NOISE, STATIC, OR A WEAK SIGNAL EVEN WHEN YOU'RE NEAR THE BASE UNIT.

---

- Household appliances plugged into the same circuit as the Base Unit can sometimes cause interference. Try moving the appliance or the Base Unit to another outlet.

---

### YOU GET NOISE, STATIC, OR A WEAK SIGNAL WHEN YOU'RE AWAY FROM THE BASE UNIT.

---

- You may be out of range. Either move close to or relocate the Base Unit.
- The layout of your home may be limiting the range. Try moving the Base Unit to another position.

---

### THE HANDSET DOES NOT RING WHEN YOU RECEIVE A CALL.

---

- Make sure you have the Handset ringer activated.
- Make sure the telephone line cord is plugged firmly into the Base Unit and the telephone jack. Make sure the power cord is plugged in.
- You may be too far from the Base Unit. And the "OUT OF RANGE" message is shown on LCD.
- You may have too many extension phones on your telephone line to allow all of them to ring. Try unplugging some of the other phones.

---

### YOU HEAR OTHER CALLS WHILE USING YOUR PHONE.

---

- Disconnect your Base Unit from the telephone jack, and plug in a regular telephone. If you still hear other calls, the problem is probably in your wiring or local service. Call your local telephone company.

---

### YOU HEAR NOISE IN THE HANDSET, AND NONE OF THE KEYS OR BUTTONS WORK.

---

- Make sure the power cord is plugged in.

---

### COMMON CURE FOR ELECTRONIC EQUIPMENT

---

If the unit does not seem to be responding normally, then try putting the Handset in the cradle. If it does not seem to respond, do the following (in the order listed):

1. Disconnect the power to the base.
2. Disconnect the Handset battery, and spare battery pack, if applicable.
3. Wait a few minutes.
4. Connect power to the Base.
5. Re-install the battery pack(s).
6. Try using your phone again.

# WARRANTY STATEMENT

## WHAT DOES OUR WARRANTY COVERS?

- Any defect in material or workmanship.

## FOR HOW LONG AFTER THE ORIGINAL PURCHASE?

- To the original purchaser only - ONE YEAR.

## WHAT WILL WE DO?

- At our option, repair or replace your unit.

## WHO DO I SEND MY UNIT, IN OR OUT OF WARRANTY?

- In the U.S. Call Customer Service for Return Authorization at: **800-667-2118**.
- Properly pack your unit. Include any cables & accessories which were originally provided with the product. We recommend using the original carton and packing materials.
- Include in the package a copy of the sales receipt or other evidence of date of original purchase (if the unit was purchased within the last twelve months).
- Print your name and address, along with a description of the defect, and include this in the package.
- Include payment for any service or repair not by warranty, as determined by **SBC** Customer Service.
- Ship the unit via UPS insured, or equivalent to the address provided by **SBC** Customer Service.

**SBC assumes no responsibility for units sent without prior Return Authorization.**

## WHAT DOES OUR WARRANTY NOT COVER?

- Batteries
- Damage from misuse, neglect, or acts of nature (lightning, floods, power surges, etc.)
- Products with may have been modified or incorporated into other products
- Products purchased and/or operated outside the USA, its territories.
- Products serviced by the owner or a service facility not expressly authorized by **SBC** Customer Service.
- Products purchased more than 12 months from current date
- Units purchased in "US IS" condition, or units purchased as "Distressed Merchandise".

## HOW DOES STATE LAW OR PROVINCIAL LAW RELATE TO THIS WARRANTY?

- This warranty gives you specific rights. You may also have other rights which vary from state to state.

# TECHNICAL SPECIFICATIONS

---

## FREQUENCY CONTROL

---

Crystal Controlled Dual PLL Synthesizer

---

## TRANSMIT FREQUENCY

---

Handset :

904.20 MHz to 925.80 MHz  
( All 20 channels within this  
range)

Base Unit:

904.20 MHz to 925.80 MHz  
(All 20 channels within this  
range)

---

## RECEIVE FREQUENCY

---

Handset :

904.20 MHz to 925.80 MHz  
( All 20 channels within this  
range)

Base Unit:

904.20 MHz to 925.80MHz  
( All 20 channels within this  
range)

---

## NOMINAL EFFECTIVE RANGE

---

Maximum power allowed by FCC and  
IC. Actual operating range may vary  
according to environmental conditions  
at the time of use.

---

## SIZE

---

Handset :

19 x 6 x 3.5cm (L x W xT)  
Maximum (Antenna  
excluded)

Base Unit:

21.5 x 16.5 x 5cm (L x W x  
T) Maximum (Antenna  
excluded)

---

## WEIGHT

---

Handset :

250 grams

Base Unit:

415 grams

---

## POWER REQUIREMENTS

---

Handset :

Self-contained nickel-  
cadmium rechargeable  
battery supply, 3.6V nominal,  
600mAh capacity.

Base Unit:

9VDC @ 500mA

---

## MEMORY

---

Speed Dial:

25 Memory locations  
16 digits and 15 characters  
per location.

CID:

Alpha Numeric Display 50  
Memory locations

---

## SPECIFICATIONS ARE TYPICAL AND MAY CHANGE WITHOUT NOTICE.

---





Printed in China

91-5152-10-00  
ISSUE 0

## TABLE OF CONTENTS

<b>INTRODUCTION</b> .....	<b>1</b>
SPECIAL FEATURES.....	2
PARTS CHECKLIST.....	3
<b>FCC REGULATIONS</b> .....	<b>4</b>
<b>IMPORTANT SAFETY INSTRUCTIONS</b> .....	<b>6</b>
<b>INSTALLING THE BATTERY PACK</b> .....	<b>8</b>
TO CHARGE THE BATTERY PACK.....	8
A WORD ABOUT RECHARGEABLE BATTERIES.....	8
REPLACING THE HANDSET BATTERY PACK.....	9
SPARE BATTERY CHARGER/POWER BACK UP FUNCTION.....	9
<b>GETTING STARTED</b> .....	<b>10</b>
<b>WALL MOUNTING</b> .....	<b>11</b>
<b>HANDSET LAYOUT</b> .....	<b>12</b>
<b>BASE LAYOUT</b> .....	<b>13</b>
<b>QUICK REFERENCE GUIDE</b> .....	<b>14</b>
SET-UP.....	14
SETTING TIME.....	14
MAKING CALLS.....	14
ANSWERING CALLS.....	15
TEMPORARY TONE.....	15
VOLUME CONTROL.....	15
RINGER CONTROL.....	15
HOLD.....	16
MUTE.....	16
REDIAL WITH THE HANDSET ON(OFF HOOK).....	16
REDIAL WITH THE HANDSET OFF(ON HOOK).....	17
PAGE/HANDSET LOCATOR.....	17
INTERCOM BETWEEN THE HANDSET AND THE BASE .....	17
CONFERENCE.....	19
REVIEWING THE CALLER ID RECORDS.....	19
MEMORY DIALING.....	19
FLASH.....	20
HANDSET SPEAKERPHONE FEATURE.....	20
<b>SOFT MENU FUNCTIONS</b> .....	<b>21</b>
RDL(Redial).....	21
MEM(Memory).....	22
MENU.....	22
<b>CALLER ID</b> .....	<b>24</b>
SAVE.....	24
DIAL.....	25
DEL(Delete).....	25
CALLER ID - CALL WAITING ID.....	26
NOTES ABOUT CALLER ID & CALL WAITING ID.....	26

## TABLE OF CONTENTS

VOICE ANNOUNCE CALLER ID.....	26
<b>PHONE BOOK.....</b>	<b>27</b>
EDITING PHONE BOOK RECORDS& VOICE ANNOUNCE RECORDS.....	27
ADDING NEW PHONE BOOK RECORDS & VOICE ANNOUNCE RECORDS.....	28
<b>OTHER MENU SETTINGS.....</b>	<b>30</b>
RINGER TONE / VOLUME.....	30
KEY BEEP ON / OFF.....	30
SET TIME.....	31
CLEAR ALL MEMORY.....	31
AUTO ANSWER ON/OFF.....	32
SET TONE /PULSE.....	32
DELETE MSG ICON.....	32
<b>HEADSET OPERATION.....</b>	<b>33</b>
<b>ADDITIONAL OPERATING TIPS.....</b>	<b>34</b>
OUT OF RANGE INDICATION.....	34
MESSAGE WAITING INDICATOR(for use with Voicemail).....	34
CUSTOM PAY-PER-USE (PPU) FEATURES.....	35
LOW BATTERY INDICATION.....	36
CHECK AC POWER INDICATION.....	36
<b>MAINTENANCE.....</b>	<b>37</b>
<b>IN CASE OF DIFFICULTY.....</b>	<b>38</b>
<b>WARRANTY STATEMENT.....</b>	<b>39</b>
<b>TECHNICAL SPECIFICATIONS.....</b>	<b>40</b>