

Important Safety Instructions

When using your telephone equipment, basic safety precautions should always be followed to reduce the risk of fire, electric shock and injury, including the following:

1. Read and understand all instructions.
2. Follow all warnings and instructions marked on the product.
3. Unplug this product from the wall outlet before cleaning. Do not use liquid or aerosol cleaners. Use a damp cloth for cleaning.
4. Do not use this product near water (for example, near a bath tub, kitchen sink or swimming pool).
5. Do not place this product on an unstable surface, such as a table, shelf, or stand. The product may fall, causing serious damage.
6. Slots and openings in the back or bottom of the base unit and handset are provided for ventilation. To protect them from overheating, these openings must not be blocked by placing the product on a soft surface such as a bed, sofa or rug. This product should never be placed near or over a radiator or heat register. This product should not be placed in any area where proper ventilation is not provided.
7. This product should be operated only from the type of power source indicated on the marking label. If you are not sure of the type of power supply in your home, consult your dealer or local power company.
8. Do not allow anything to rest on the power cord. Do not install this product where the cord may have anyone walking on it.
9. Never push objects of any kind into this product through slots in the base or handset as they may touch dangerous voltage points or short out parts that could result in a risk of fire or electric shock. Never spill liquid of any kind on the product.
10. To reduce the risk of electric shock, do not disassemble this product, but take it to an authorized service facility. Opening or removing parts of the base or handset other than specified access doors may expose you to dangerous voltages or other risks. Incorrect reassembling can cause electric shock when the product is subsequently used.
11. Do not overload wall outlets and extension cords as this can result in the risk of fire or electric shock.
12. Unplug this product from the wall outlet and refer servicing to an authorized service facility under the following conditions:
 - A. When the power supply cord or plug is damaged or frayed.
 - B. If liquid has been spilled onto the product.
 - C. If the product has been exposed to rain or water.
 - D. If the product does not operate normally by following the operating instructions. Adjust only those controls that are covered by the operating instructions, as improper adjustment of other controls may result in damage and often requires extensive work by an authorized technician to restore the product to normal operation.
 - E. If the product has been dropped and the base and/or handset has been damaged.

Important Safety Instructions

- F. If the product exhibits a distinct change in performance.
13. Avoid using a telephone (other than cordless) during an electrical storm. There is a remote risk of electric shock from lightning.
 14. Do not use the telephone to report a gas leak in the vicinity of the leak.
 15. Only put the handset of your telephone next to your ear when it is in normal talk mode.

WARNING: To insure your safety from possible electric shock, **only** use the enclosed VTech audio patch cable to record custom ring tones. Do **NOT** leave the audio patch cable attached to the handset while charging in its base.

Introduction

EXPAND YOUR i 5858 or i 5871 SYSTEMS. YOUR BASE WILL WORK WITH UP TO 8 HANDSETS!!!

IMPORTANT:

The **i 5808** is an **accessory handset only** for use with the **i 5858 or i 5871** systems. You must have one of these base units in order to use the **i 5808** accessory handset.

This manual is designed to familiarize you with the **i 5808** accessory handset setup, registration and basic functions. For detailed operational instructions, please refer to your **i 5858 or i 5871** user's manual.

Parts Check List

1. Handset
2. Battery
3. Belt Clip
4. Handset Charger
5. Special Features Guide
6. User's Manual
7. VTech Phonebook Manager CD
8. Audio Patch Cable
9. USB Cable

To purchase replacement batteries, visit us on the web at www.vtechphones.com or call VTech Communications, Inc. at 1-800-595-9511. In Canada, call VTech Telecommunications Canada Ltd. at 1-800-267-7377.

NOTE: Use only VTech batteries P/N 89-1324-00-00.



Handset



Battery



Belt Clip

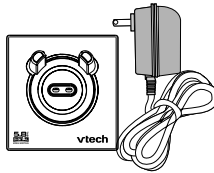

Charger

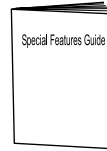

Special Features Guide
(English and Spanish)

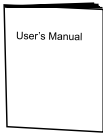

User's Manual
(English and Spanish)

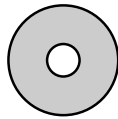

VTech Phonebook
Manager CD

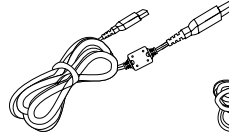

USB Cable



Audio Patch Cable

The Handset Layout

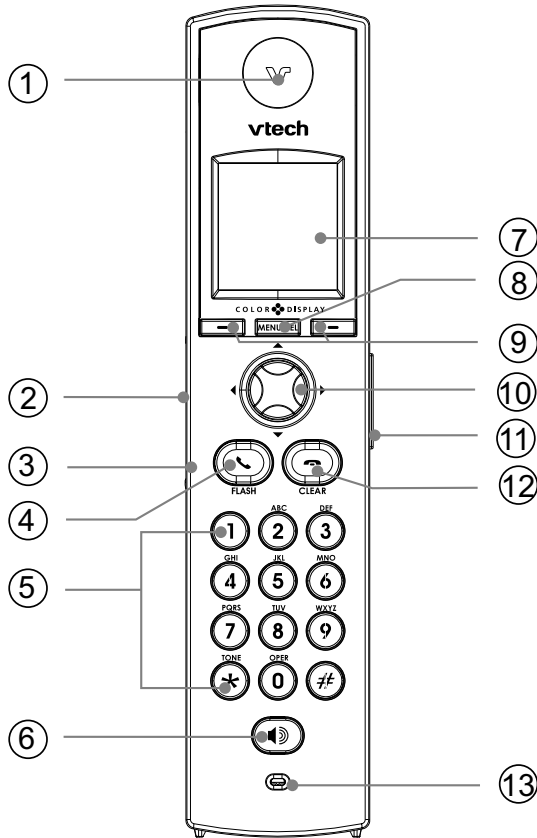

- | | |
|---|-------------------------------|
| 1. Earpiece | 7. LCD Display |
| 2. USB Cable Jack | 8. Menu/Select Key |
| 3. Headset Jack / Audio
Patch Cable Jack (2.5mm) | 9. Softkeys |
| 4. On/Flash Key | 10. NavKeys (Navigation Keys) |
| 5. Dialing Keys (0-9, *, #) | 11. Volume Keys |
| 6. Speakerphone Key | 12. Off/Clear Key |
| | 13. Microphone |

Setup

Connecting Power to Handset Charger

Because the **i 5808** is an accessory handset to the **i 5858** or **i 5871** system, all you need to do is choose the location for your handset charger, and plug in the power supply into an electrical outlet.

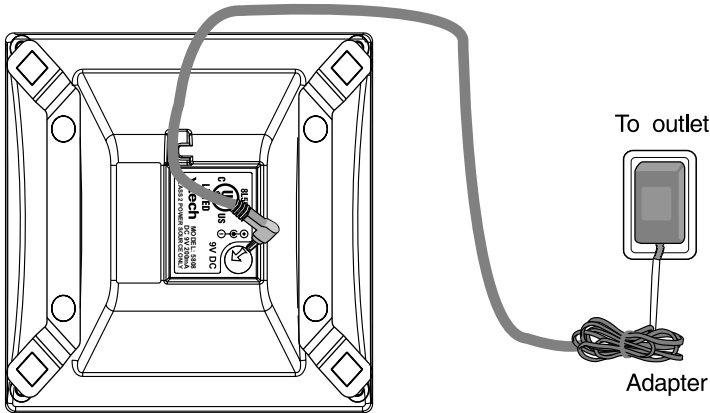

Installation and Charge of Battery in Handset

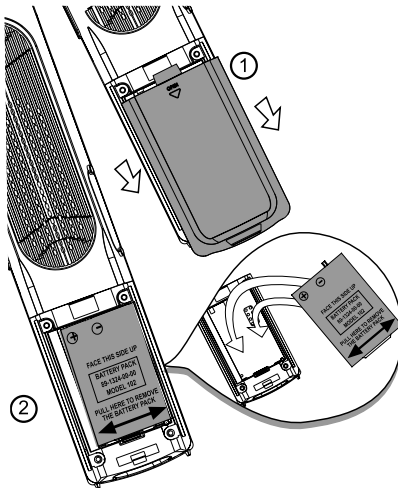

1. Remove the battery cover and place the battery in the compartment with the metal contacts aligning, as shown in the diagram.
2. Replace the battery compartment cover by sliding it upwards.
3. If the new battery is not already charged, place the handset in its charger, and allow it to charge for 12 hours. After initial charge, a maintenance charge of eight hours should be sufficient.

Setup

Battery Life

A fully charged battery provides an average talk time of about seven hours or standby time of four days.

NOTE: Talk time and standby time may vary depending on operating conditions.

Battery Indicator

Ten minutes before the battery charge level gets too low to operate the handset, an empty battery icon will start flashing, five short tones are generated and a **Low Battery** message is displayed.

If you continue to use the handset without charging or replacing the battery (spare batteries purchased separately), the handset will turn off automatically when the battery charge level is no longer sufficient to power up the handset, and the call will be dropped.

Charging the Handset Battery

After a low battery indication, place the handset in the charger and make sure the **CHARGING** light turns on. With the exception of the first charge, the battery typically takes eight hours to fully charge.

NOTE: If you repeatedly get a low battery indication, even after eight hours of charging, then the battery should be replaced.

As you register additional **i 5808** handsets to your **i 5858** or **i 5871** system, they will be assigned extension numbers in the following order: **HANDSET 2, HANDSET 3, HANDSET 4**, and so forth.

Whenever a charged handset battery is installed, the handset will automatically begin **Searching for Base...** (if previously registered), or it will prompt you to **REGISTER with the registration guide** to register the new handset.

BEFORE USING YOUR HANDSET(S), CAREFULLY PEEL OFF THE PROTECTIVE FILM COVERING THE DISPLAY.

Registration

Installation and Registration of Accessory Handset

Your **i 5808** is an accessory handset **ONLY** and requires either a **i 5858** or **i 5871** base unit to operate.

Registering the i 5808 handset for the first time

After charging the handset will display registration directions, which are as follows:

- On the base unit, press **MENU**, then select **REGISTER HANDSET**.

On the **i 5858** base



On the **i 5871** base



- When the base unit shows **READY TO REGISTER NEW HANDSET**, press **REGISTER** on the handset.

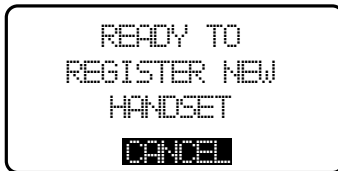



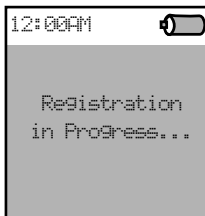







- The handset displays **Registration in Progress**.



- Within approximately 15 – 60 seconds the base and handset will beep, and the newly registered handset will be assigned the lowest extension number not previously assigned to another system handset (1 – 8).

Handset Indicators

Handset Icons

Icon	Description
	<p><u>Line In Use Indicator</u></p> <ul style="list-style-type: none"> On steady when an extension handset or parallel set is in use.
	<p><u>Hold Indicator</u></p> <ul style="list-style-type: none"> Flashes when a call is on hold.
	<p><u>Mute Indicator</u></p> <ul style="list-style-type: none"> Flashes when the handset microphone is muted.
	<p><u>Ringer Off Indicator</u></p> <ul style="list-style-type: none">  is displayed when the ringer is turned off.
	<p><u>Battery Indicator</u></p> <ul style="list-style-type: none"> When the handset is removed from the charger, this lets you know the level of charge in the battery, from FULL () to EMPTY () Cycles (low, medium, and full) when handset battery is charging. Flashes when a low battery condition is detected.
	<p><u>Message Waiting Indicator</u></p> <ul style="list-style-type: none"> Flashes to indicate that you have new voicemail messages(only for i 5858 system).
	<p><u>New Message Indicator</u></p> <ul style="list-style-type: none"> Flashes when there is a new message in the answer machine(only for i 5871 system).

Handset LEDs

LED	Description
	On when handset speakerphone is in use.

Headset Operation

Your **i 5808** handset is equipped with a 2.5mm headset jack for use with an optional accessory headset for handsfree operation. If you choose to use the headset option, you must obtain an optional accessory headset, which is compatible with the **i 5808**. For best results, use a VTech 2.5mm headset.

To purchase a headset, visit us on the web at www.vtechphones.com or call VTech Customer Service at 1-800-595-9511.

Once you have a compatible 2.5mm headset, locate the headset jack on the **i 5808** handset. Connect the plug on the headset cord to the jack (under a small rubber flag) on the cordless handset. The plug should fit securely. Do not force the connection.

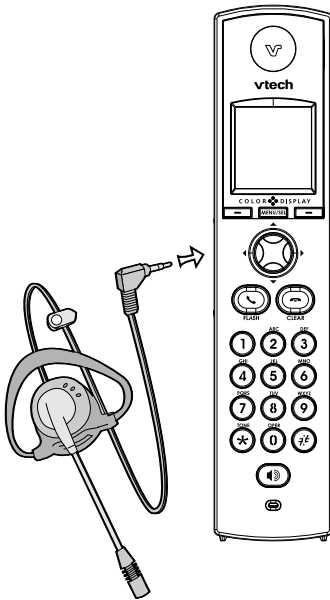

NOTE:

Whenever a compatible headset is connected to the cordless handset, the microphone on the handset will be muted. This is done to limit the effect of background noise.

Many compatible headsets have a reversible, monaural design. This means you can wear your headset on either ear, leaving one ear free for other conversations.

Advance Operation

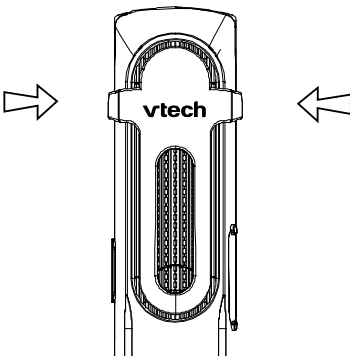

Belt Clip

The **i 5808** is also equipped with a detachable belt clip. Align the pins on the inside edge of the clip with the notches on the sides of the Handset. The belt clip should snap securely into place. Do not force the connection.

Maintenance

Taking care of your telephone

Your cordless telephone contains sophisticated electronic parts, so it must be treated with care.

Avoid rough treatment

Place the Handset down gently. Save the original packing materials to protect your telephone if you ever need to ship it.

Avoid water

Your telephone can be damaged if it gets wet. Do not use the Handset outdoors in the rain, or handle it with wet hands. Do not install your Base Unit near a sink, bathtub, or shower.

Electrical storms

Electrical storms can sometimes cause power surges harmful to electronic equipment. For your own safety, use caution when using electric appliances during storms.

Cleaning your telephone

Your telephone has a durable plastic casing that should retain its luster for many years. Clean it only with a soft cloth slightly dampened with water or a mild soap. Do not use excess water or cleaning solvents of any kind.

Remember that electrical appliances can cause serious injury if used when you are wet or standing in water. If your Base Unit should fall into water, **DO NOT RETRIEVE IT UNTIL YOU UNPLUG THE POWER CORD AND TELEPHONE LINE CORDS FROM THE WALL.** Then pull the unit out by the unplugged cords.

In Case Of Difficulty

If you have difficulty operating your phone, the suggestions below should solve the problem. If you still have difficulty after trying these suggestions, call VTech Communications at 1-800-595-9511. In Canada, call VTech Telecommunications Canada Ltd. at 1-800-267-7377.

The phone doesn't work at all

- Make sure the power cord is plugged in.
- Make sure the telephone line cord is plugged firmly into the base unit and the telephone wall jack.
- Make sure the batteries are properly charged. If you get a **Low Battery** message or indication, the batteries need charging.

No dial tone

- First try all the suggestions above.
- If you still don't hear a dial tone, disconnect the base unit from the telephone jack and connect a different phone. If there is no dial tone on that phone either, the problem is in your wiring or local service. Contact your local telephone company.

You get noise, static, or a weak signal even when you're near the base unit

- Household appliances plugged into the same circuit as the base unit can sometimes cause interference. Try moving the appliance or the base unit to another outlet.

You get noise, static, or a weak signal when you're away from the Base Unit

- You may be out of range. Either move closer to the base, or relocate the base unit.
- The layout of your home may be limiting the range. Try moving the base unit to another position.

The handset does not ring when you receive a call

- Make sure you have the ringer activated.
- Make sure the telephone line cord is plugged firmly into the base unit and the telephone jack. Make sure the power cord is plugged in.
- You may be too far from the base unit.
- You may have too many extension phones on your telephone line to allow all of them to ring. Try unplugging some of the other phones.

In Case Of Difficulty

Your Handset vibrates or shakes when a call comes in

- It is likely that your Vibrating Handset Ringer option has been set to **ON**.

You hear other calls while using your phone

- Disconnect your Base Unit from the telephone jack, and plug in a regular telephone. If you still hear other calls, the problem is probably in your wiring or local service. Call your local telephone company.

You hear noise in the Handset, and none of the keys or buttons work

- Make sure the power cord is plugged in.

Common cure for electronic equipment

If the unit does not seem to be responding normally, then try putting the Handset in its Base. If it does not seem to respond, do the following (in the order listed):

1. Disconnect the power to the base.
2. Disconnect the handset battery, and spare battery, if applicable.
3. Wait a few minutes.
4. Connect power to the base.
5. Re-install the battery.
6. Wait for the handset to re-establish its link with the base. To be safe, allow up to one minute for this to take place.

You cannot hear recorded messages

- Using the base volume control, raise the volume to a comfortable listening level.

Warranty Statement

What does this limited warranty cover?

- The manufacturer of this VTech product, VTech Communications, warrants to the holder of a valid proof of purchase (“Consumer” or “you”) that the product and all accessories provided by VTech in the sales package (“Product”) are free from material defects in material and workmanship, pursuant to the following terms and conditions, when installed and used normally and in accordance with operation instructions. This limited warranty extends only to the Consumer for Products purchased and used in the United States of America.

What will VTech Communications do if the Product is not free from material defects in materials and workmanship during the limited warranty period (“Materially Defective Product”)?

- During the limited warranty period, VTech’s authorized service representative will repair or replace at VTech’s option, without charge, a Materially Defective Product. If we repair this product, we may use new or refurbished replacement parts. If we choose to replace this product, we may replace it with a new or refurbished product of the same or similar design. VTech will return repaired or replacement products to you in working condition. VTech will retain defective parts, modules, or equipment. Repair or replacement of Product, at VTech’s option, is your exclusive remedy. You should expect the repair or replacement to take approximately 30 days.

How long is the limited warranty period?

- The limited warranty period for the product extends for ONE (1) YEAR from the date of purchase if we repair or replace a Materially Defective Product under the terms of this limited warranty. This limited warranty also applies to repaired or replacement Products for a period of either (a) 90 days from the date the repaired or replacement Product is shipped to you or (b) the time remaining on the original one year warranty; whichever is longer.

What is not covered by this limited warranty?

This limited warranty does not cover:

1. Product that has been subjected to misuse, accident, shipping or other physical damage, improper installation, abnormal operation or handling, neglect, inundation, fire, water or other liquid intrusion; or
2. Product that has been damaged due to repair, alteration or modification by anyone other than an authorized service representative of VTech; or
3. Product to the extent that the problem experienced is caused by signal conditions, network reliability or cable or antenna systems; or
4. Product to the extent that the problem is caused by use with non-VTech electrical accessories; or
5. Product whose warranty/quality stickers, Product serial numbers plates or electronic serial numbers have been removed, altered or rendered illegible; or
6. Product purchased, used, serviced or shipped for repair from outside the United States, or used for commercial or institutional purposes (including but not limited to Products used for rental purposes); or
7. Product returned without valid proof of purchase (see 2 below); or
8. Charges for installation or set up, adjustment of customer controls and installation or repair of systems outside the unit.

Warranty Statement

How do you get warranty service?

- To obtain warranty service in the United States of America, call 1-800-595-9511 for instructions regarding where to return the Product. Before calling for service, please check the user's manual. A check of the Product controls and features may save you a service call.
- Except as provided by applicable law, you assume the risk of loss or damage during transit and transportation and are responsible for delivery or handling charges incurred in the transport of Product(s) to the service location. VTech will return repaired or replaced product under this limited warranty to you, transportation, delivery or handling charges prepaid. VTech assumes no risk for damage or loss of the Product in transit.
- If the Product failure is not covered by this limited warranty, or proof of purchase does not meet the terms of this limited warranty, VTech will notify you and will request that you authorize the cost of repair prior to any further repair activity. You must pay for the cost of repair and return shipping costs for the repair of Products that are not covered by this limited warranty.

What must you return with the Product to get warranty service?

1. Return the entire original package and contents including the Product to the VTech service location along with a description of the malfunction or difficulty;
2. Include "valid proof of purchase" (sales receipt) identifying the Product purchased (Product model) and the date of purchase or receipt; and
3. Provide your name, complete and correct mailing address, and telephone number.

Other Limitations

- This warranty is the complete and exclusive agreement between you and VTech. It supersedes all other written or oral communications related to this Product. VTech provides no other warranties for this product. The warranty exclusively describes all of VTech's responsibilities regarding the product.

There are no other express warranties. No one is authorized to make modifications to this limited warranty and you should not rely on any such modification.

State Law Rights: This warranty gives you specific legal rights, and you may also have other rights which vary from state to state.

Limitations: Implied warranties, including those of fitness for a particular purpose and merchantability (an unwritten warranty that the product is fit for ordinary use) are limited to one year from date of purchase. Some states do not allow limitations on how long an implied warranty lasts, so the above limitation may not apply to you.

- In no event shall VTech be liable for any indirect, special, incidental, consequential, or similar damages (including, but not limited to lost profits or revenue, inability to use the product, or other associated equipment, the cost of substitute equipment, and claims by third parties) resulting from the use of this product. Some states do not allow the exclusion or limitation of incidental or consequential damages, so the above limitation or exclusion may not apply to you.

FCC, ACTA and IC Regulations

This equipment complies with Parts 15 of the Federal Communications Commission (FCC) rules for the United States. It also complies with regulations RSS210 and CS-03 of Industry and Science Canada. Operation is subject to the following two conditions: (1) this device may not cause interference, and (2) this device must accept any interference, including interference that may cause undesired operation of the device.

A label is located on the underside of the Base Unit containing either the FCC registration number and Ringer Equivalence Number (REN) or the IC registration number and Load Number. You must, upon request, provide this information to your local telephone company.

This equipment is compatible with inductively coupled hearing aids.

Should you experience trouble with this telephone equipment, please contact: **VTech Communications Inc. CUSTOMER SERVICE at 1-800-595-9511. In Canada, call VTech Telecommunications Canada Ltd. at 1-800-267-7377** for repair/warranty information. The telephone company may ask you to disconnect this equipment from the line network until the problem has been corrected.

FCC Part 15

Warning: Changes or modifications to this unit not expressly approved by the party responsible for compliance could void the user's authority to operate the equipment. The equipment has been tested and found to comply with part 15 of the FCC rules. These limits are designed to provide reasonable protection against harmful interference in a residential installation. This equipment generates, uses and can radiate radio frequency energy and, if not installed and used in accordance with the instructions, may cause harmful interference to radio communications. However, there is no guarantee that interference will not occur in a particular installation. If this equipment does cause harmful interference to radio or television reception, which can be determined by turning the equipment off and on, the user is encouraged to try and correct the interference by one or more of the following measures:

- Reorient or relocate the receiving antenna.
- Increase the separation between the equipment and receiver.
- Connect the equipment into an outlet or on a circuit different from that to which the receiver is connected.
- Consult the dealer or an experienced radio/TV technician for help.

To ensure safety of users, the FCC has established criteria for the amount of radio frequency energy that can be safely absorbed by a user or bystander according to the intended usage of the product. This product has been tested and found to comply with the FCC criteria. The handset has such a low power that it does not require testing. It may be safely held against the ear of the user. The base unit shall be installed & used such that parts of the user's body other than the hands should be maintained at a comfortable distance of approximately 20 cm or more. If you choose to use a clipping device, please make sure to only use the supplied VTech belt clip.

FCC and ACTA Information

If this equipment was approved for connection to the telephone network prior to July 23, 2001, it complies with Part 68 of the Federal Communications Commission (FCC)

FCC, ACTA and IC Regulations

rules. If the equipment was approved after that date, it complies with the Part 68 rules and with Technical Requirements for Connection of Equipment to the Telephone Network adopted by the Administrative Council for Terminal Attachments (ACTA). We are required to provide you with the following information.

1. Product identifier and REN information

The label on the back or bottom of this equipment contains, among other things, an identifier indicating product approval and the Ringer Equivalence Number (REN). This information must be provided to your local telephone company upon request. For equipment approved prior to July 23, 2001, the product identifier is preceded by the phrase "FCC Reg No." and the REN is listed separately. For equipment approved after that date, the product identifier is preceded by "US" and a colon (:), and the REN is encoded in the product identifier without a decimal point as the sixth and seventh characters following the colon. For example, the product identifier US:AAAEQ03T123XYZ would indicate an REN of 0.3.

The REN is used to determine how many devices you may connect to your telephone line and still have them ring when you are called. In most, but not all areas, the sum of all RENs should be five (5.0) or less. For more information, please contact your local telephone company.

2. Connection and use with the nationwide telephone network

The plug and jack used to connect this equipment to the premises wiring and the telephone network must comply with the applicable Part 68 rules and technical requirements adopted by ACTA. A compliant telephone cord and modular plug is provided with this product. It is designed to be connected to a compatible modular jack that is also compliant. An RJ11 jack should normally be used for connecting to a single line and an RJ14 jack for two lines. See Installation Instructions in this user's manual. This equipment may not be used with Coin Telephone Lines or with Party Lines. If you have specially wired alarm dialing equipment connected to your telephone line, ensure the connection of this equipment does not disable your alarm equipment. If you have questions about what will disable alarm equipment, consult your telephone company or a qualified installer.

3. Repair instructions

If this equipment is malfunctioning, it must be unplugged from the modular jack until the problem has been corrected. Repairs to this telephone equipment can only be made by the manufacturer or its authorized agents. For repair procedures, follow the instructions outlined under the Limited Warranty.

4. Rights of the telephone company

If this equipment is causing harm to the telephone network, the telephone company may temporarily discontinue your telephone service. The telephone company is required to notify you before interrupting service. If advance notice is not practical, you will be notified as soon as possible. You will be given the opportunity to correct the problem and the telephone company is required to inform you of your right to file a complaint with the FCC. Your telephone company may make changes in its facilities, equipment, operation, or procedures that could affect the proper functioning of this product. The telephone company is required to notify you if such changes are planned.

FCC, ACTA and IC Regulations

5. Hearing aid compatibility

If this product is equipped with a corded or cordless handset, it is hearing aid compatible.

6. Programming/testing of emergency numbers

If this product has memory dialing locations, you may choose to store police, fire department and emergency medical service telephone numbers in these locations. If you do, please keep three things in mind:

- a. We recommend that you also write the telephone number on the directory card, so that you can still dial the emergency number manually if the memory dialing feature doesn't work.
- b. This feature is provided only as a convenience, and the manufacturer assumes no responsibility for customer reliance upon the memory feature.
- c. Testing the emergency telephone numbers you have stored is not recommended. However, if you do make a call to an emergency number:
 - You must remain on the line and briefly explain the reason for the call before hanging up.
 - Programming/testing of emergency numbers should be performed during off-peak hours, such as in the early morning or late evening, when the emergency services tend to be less busy.

IC (Industry Canada)

This telephone is registered for use in Canada.

The term "IC:" before the radio certification number only signifies that Industry Canada technical specifications were met.

Notice: This equipment meets the applicable Industry Canada Terminal Equipment Technical Specifications. This is confirmed by the registration number. The abbreviation, IC, before the registration number signifies that registration was performed based on a Declaration of Conformity indicating that Industry Canada technical specifications were met. It does not imply that Industry Canada approved the equipment.

Notice: The Ringer Equivalence Number (REN) for this terminal equipment is 0.1. The REN assigned to each terminal equipment provides an indication of the maximum number of terminals allowed to be connected to a telephone interface. The termination on an interface may consist of any combination of devices subject only to the requirement that the sum of the Ringer Equivalence Numbers of all the devices does not exceed five.

Before installing this equipment, users should ensure that it is permissible to be connected to the facilities of the local telecommunications company. The equipment must also be installed using an acceptable method of connection. The customer should be aware that compliance with the above conditions may not prevent degradation of services in some situations.

Repairs to certified equipment should be made by an authorized Canadian maintenance facility designated by the Supplier. Any repairs or alterations made by the user to this equipment, or equipment malfunctions, may give the telecommunications company cause to request the user to disconnect the equipment.

FCC, ACTA and IC Regulations

Users should ensure for their own protection that the electrical ground connections of the power utility, telephone lines and internal metallic water pipe system, if present, are connected together. This precaution may be particularly important in rural areas.

Caution: Users should not attempt to make such connections themselves, but should contact the appropriate electrical inspection authority or electrician as appropriate.

Your Cordless Phone is designed to operate at the maximum power allowed by the FCC and IC. This means your Handset and Base Unit can communicate only over a certain distance - which will depend on the location of the Base Unit and Handset, weather, and the construction and layout of your home or office.

Technical Specifications

FREQUENCY CONTROL

Crystal controlled
PLL synthesizer

TRANSMIT FREQUENCY

Base: 5725-5850 MHz
Handset: 5725-5850 MHz

RECEIVE FREQUENCY

Base: 5725-5850 MHz
Handset: 5725-5850 MHz

CHANNELS

95 Channels

SIZE

Handset: 190mm x 42mm x 31mm
Charger: 87.0mmx90.0mmx84mm
(including antenna)

NOMINAL EFFECTIVE RANGE

Maximum power allowed by FCC and IC. Actual operating range may vary according to environmental conditions at the time of use.

WEIGHT

Handset: 145 grams
(excluding battery)
Charger: 182 grams

POWER REQUIREMENTS

Handset: 3 cell AAA 3.6V 800mAh
NiMH Battery

Charger: 9V DC @200mA

MEMORY

Handset:

Phonebook: 100 Memory locations;
up to 32 digits, 16 characters per
location.

Caller ID: 100 Memory locations

**SPECIFICATIONS ARE TYPICAL
AND MAY CHANGE WITHOUT
NOTICE.**



vtech

VTECH TELECOMMUNICATIONS LTD.

A member of THE VTECH GROUP OF COMPANIES.

Distributed in the U.S.A. by VTech Communications Inc.,
Beaverton, Oregon, 97008

Distributed in Canada by VTech Telecommunications Canada
Ltd., 7671 Alderbridge Way, Richmond, B.C. V6X 1Z9.

Copyright 2005 for VTECH TELECOMMUNICATIONS LTD.
Printed in China

91-000xxx-010-000
ISSUE 0





Table of Contents

Introduction	1
Important Safety Instructions	2
Getting Started	4
Parts Check List.....	4
The Handset Layout.....	5
Setup.....	6
Registration.....	8
Basic Operation	9
Handset Indicators.....	9
Additional Information	10
Headset Operation.....	10
Belt Clip.....	10
Maintenance.....	11
In Case Of Difficulty.....	12
Warranty Statement.....	14
FCC, ACTA and IC Regulations.....	16
Technical Specifications.....	20

Congratulations on your purchase
of this VTech product

NEED HELP?

Our representatives are here
to help you with any questions
concerning the operation of this
product, available accessories,
or any other related issues.

Call Toll Free:

1-800-595-9511

In Canada, Call:

1-800-267-7377

or visit our website at
www.vtechphones.com