

Legend	
BGP	Red dashed line
OSPF	Blue dashed line
EIGRP	Purple dashed line
RIP	Yellow dashed line

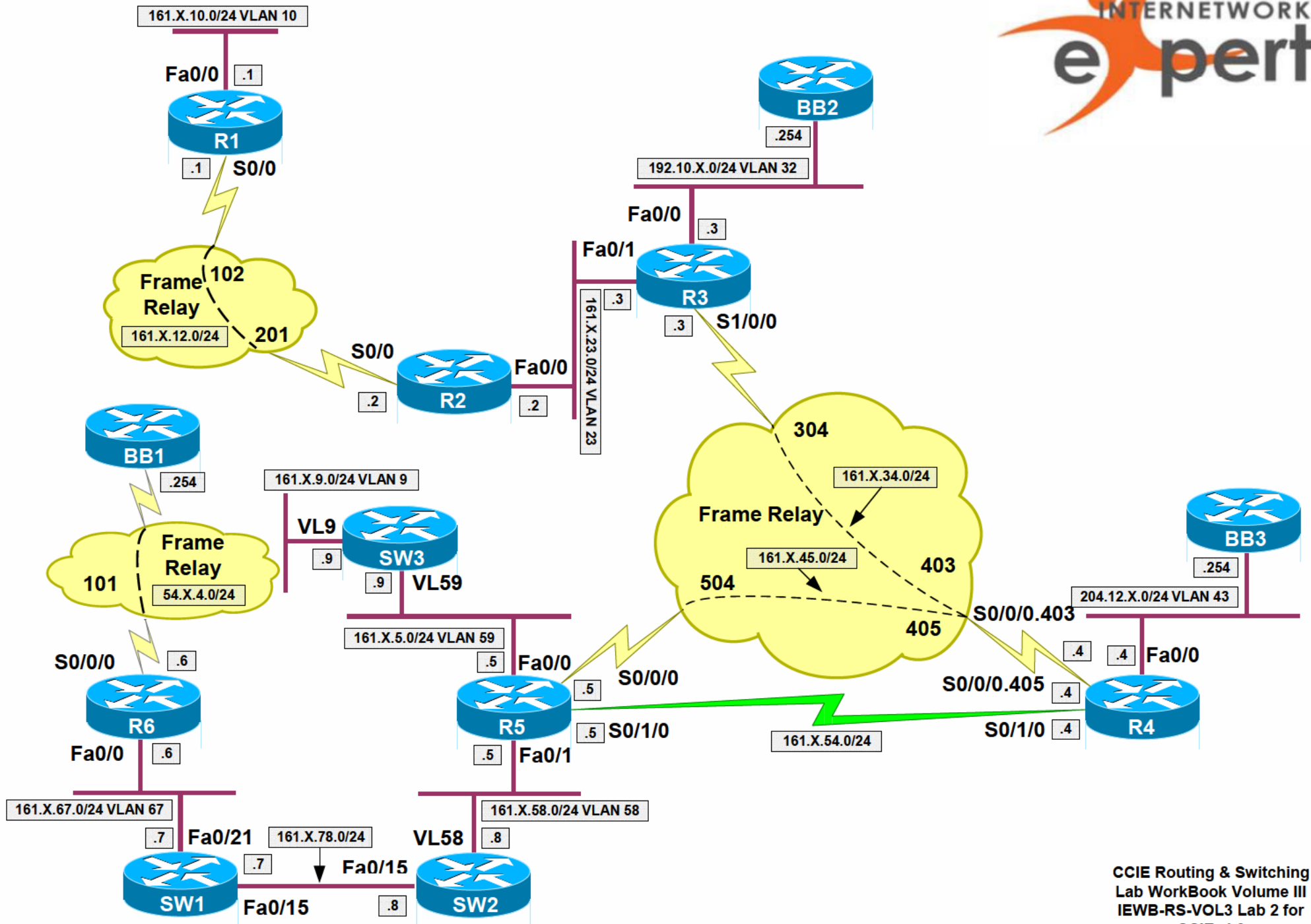

Legend

- BGP (Red dashed line)
- OSPF (Blue dashed line)
- EIGRP (Purple dashed line)
- RIPv2 (Green dashed line)

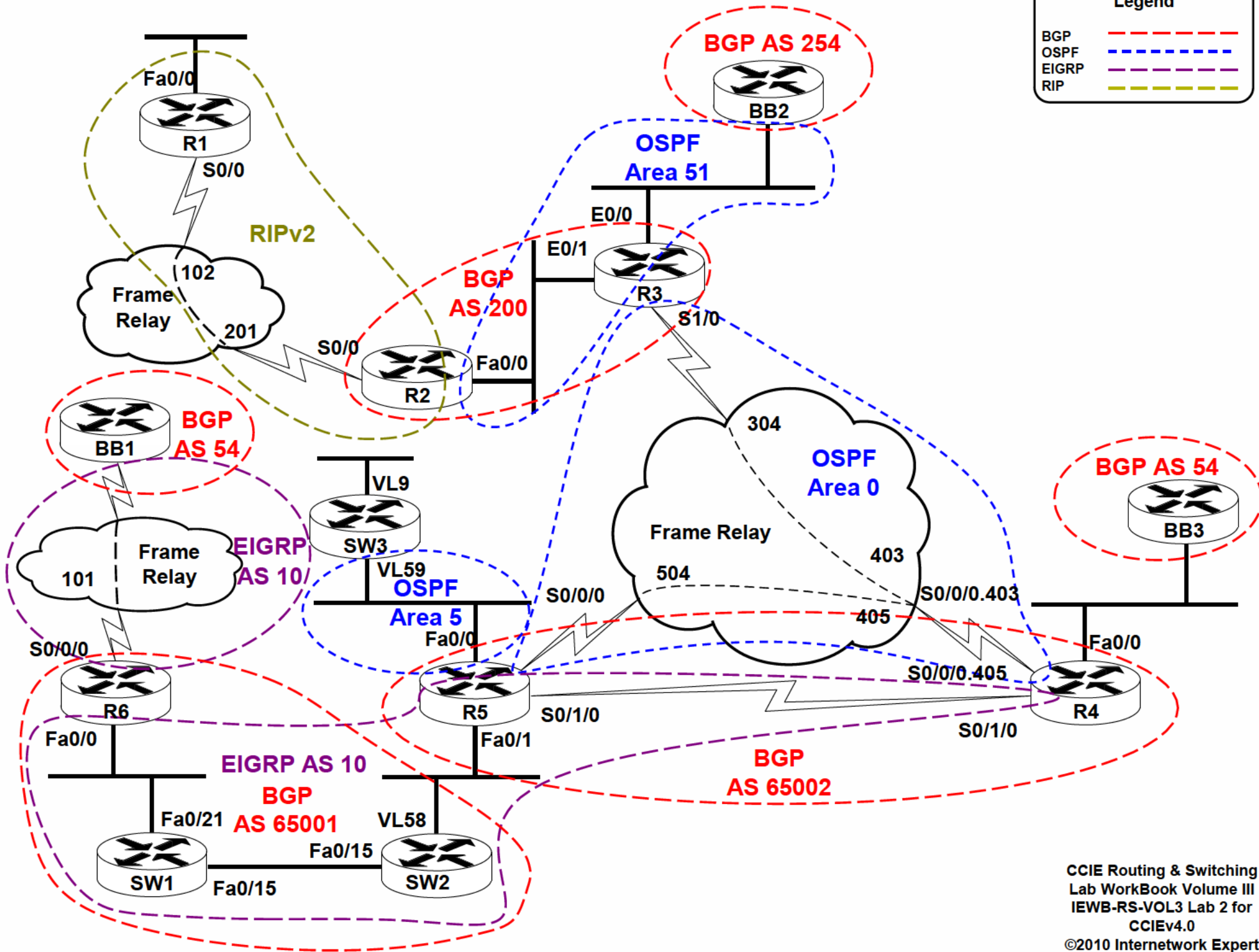

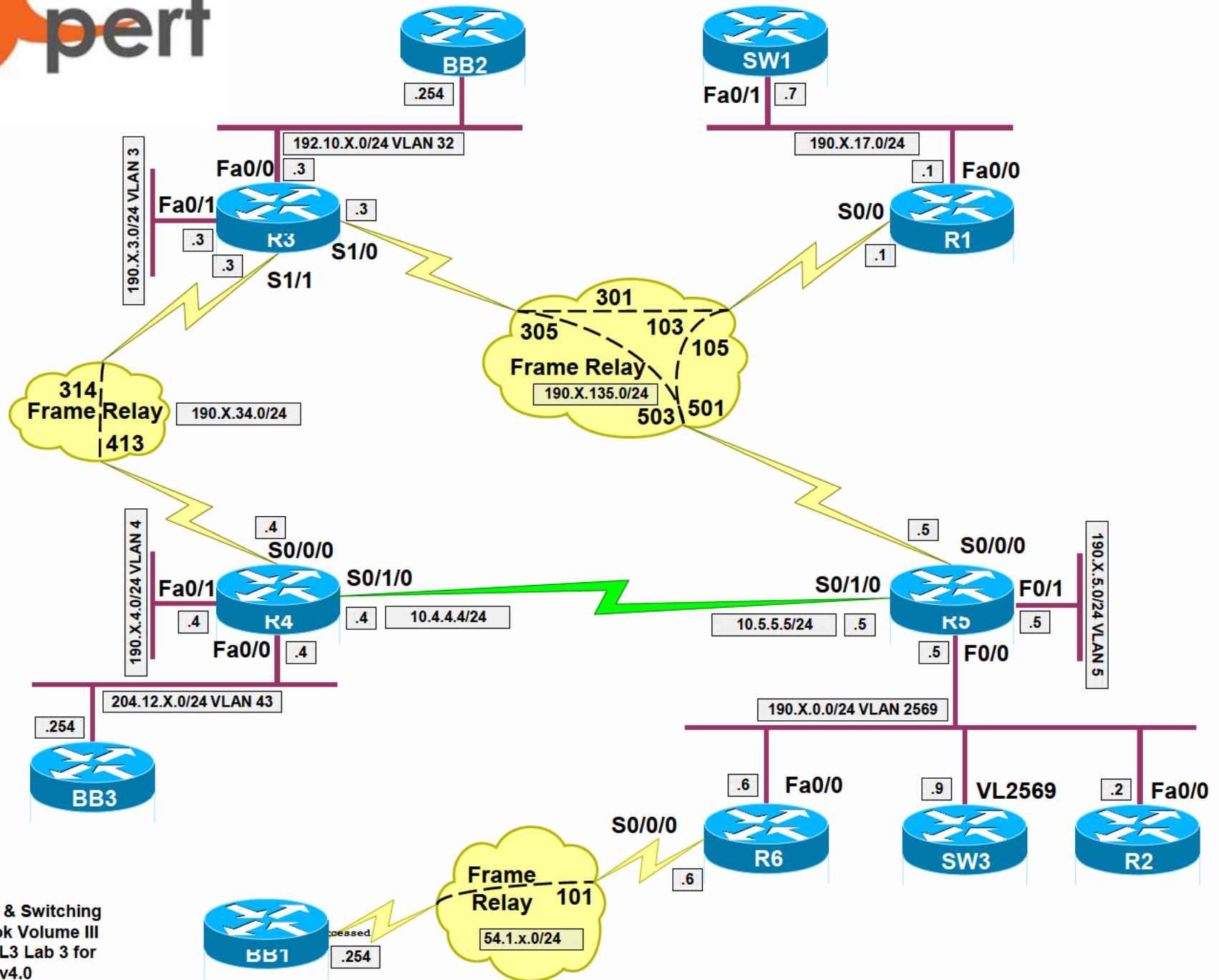

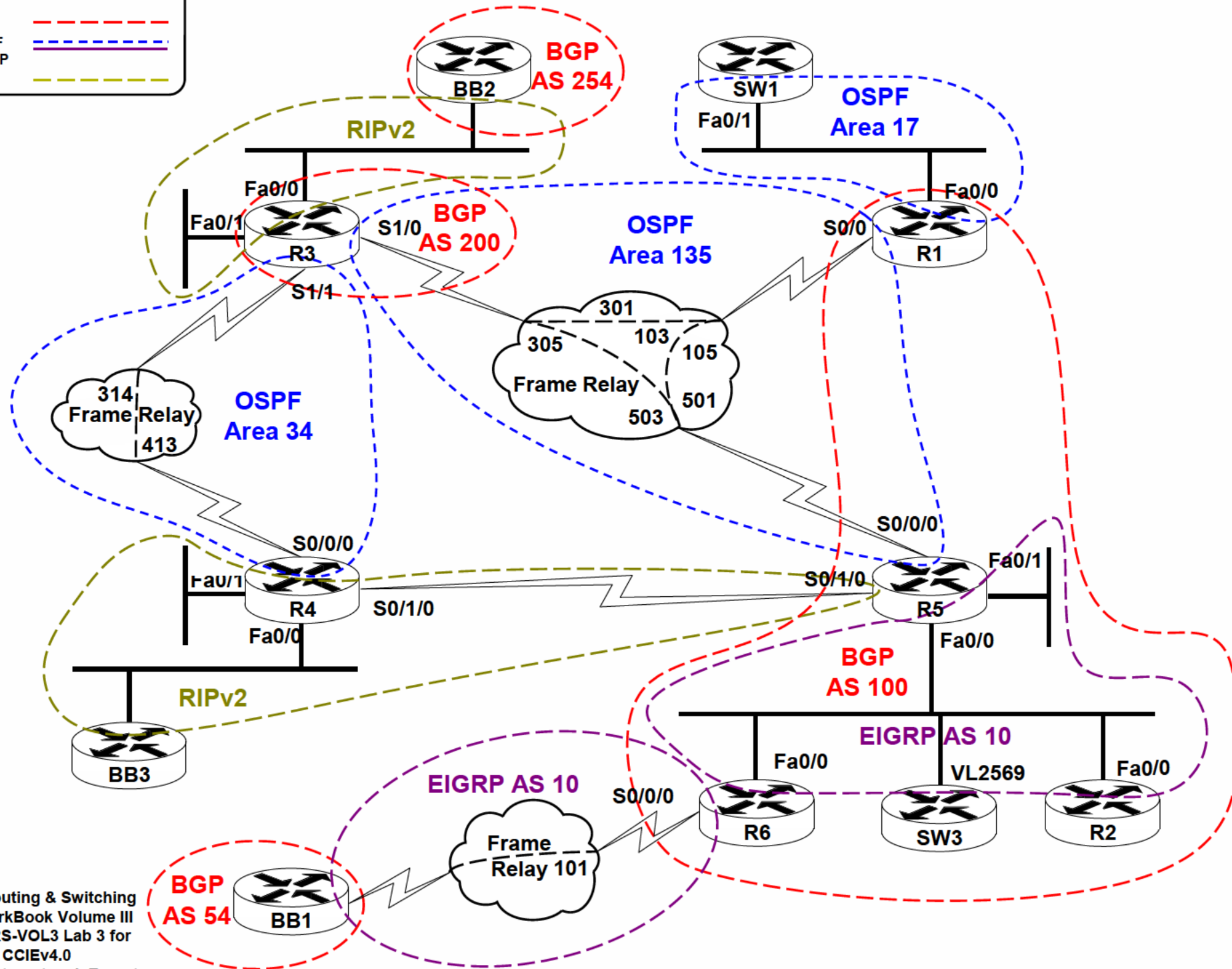
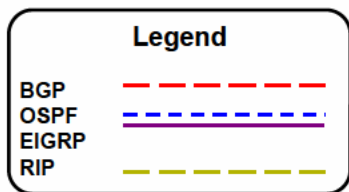

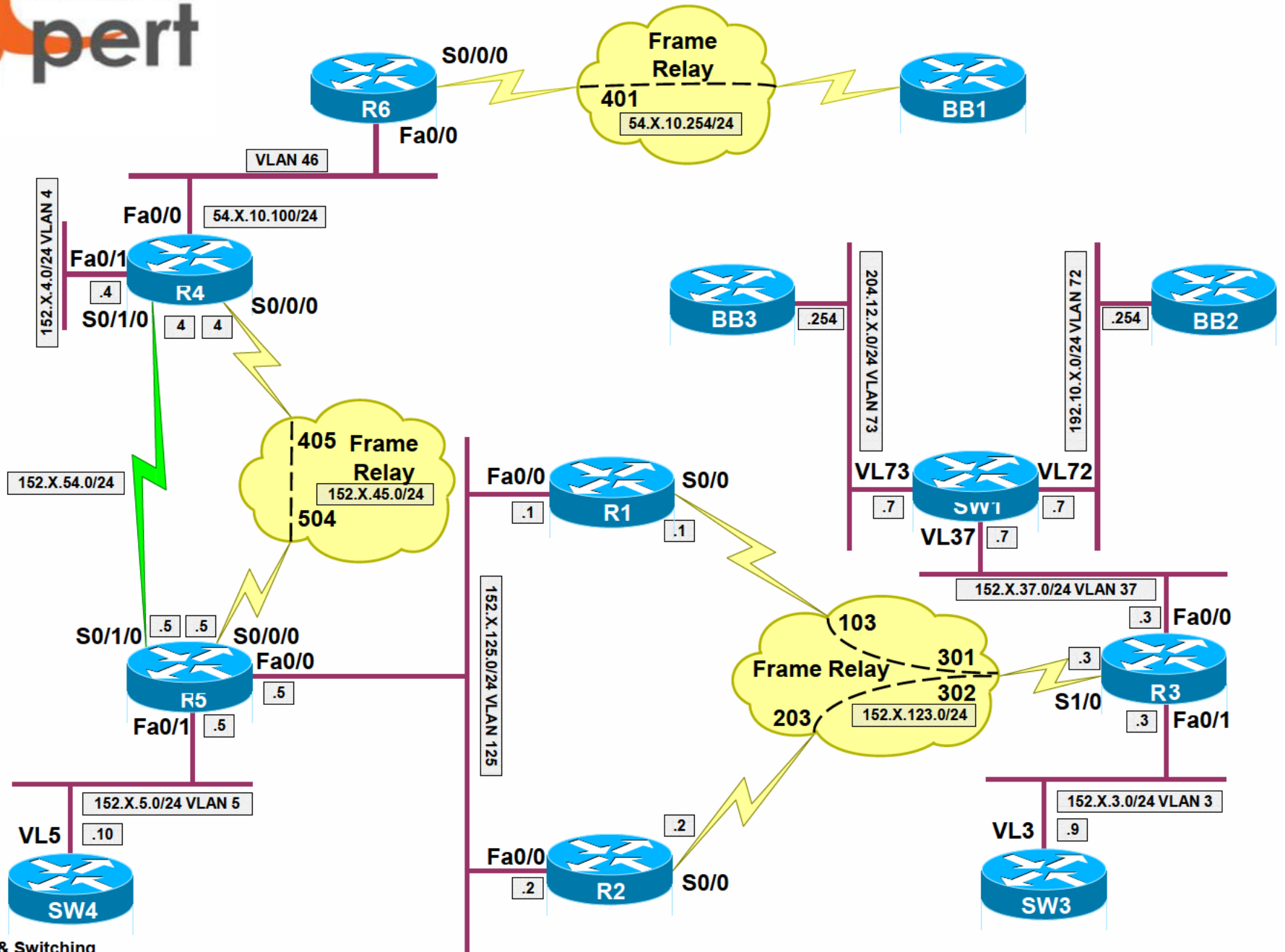

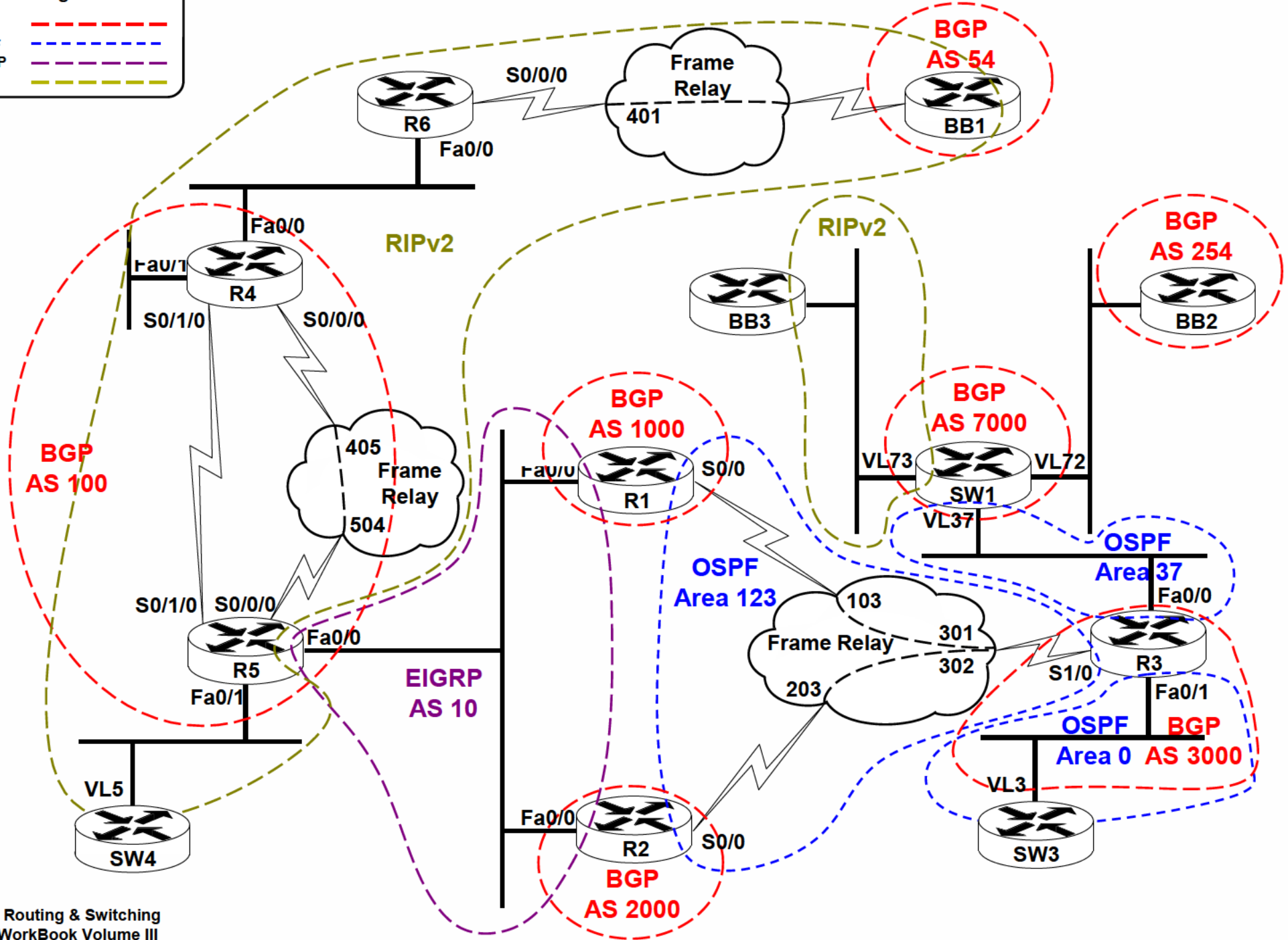
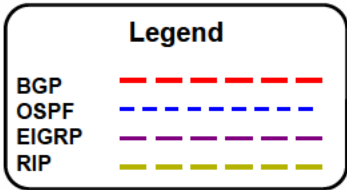

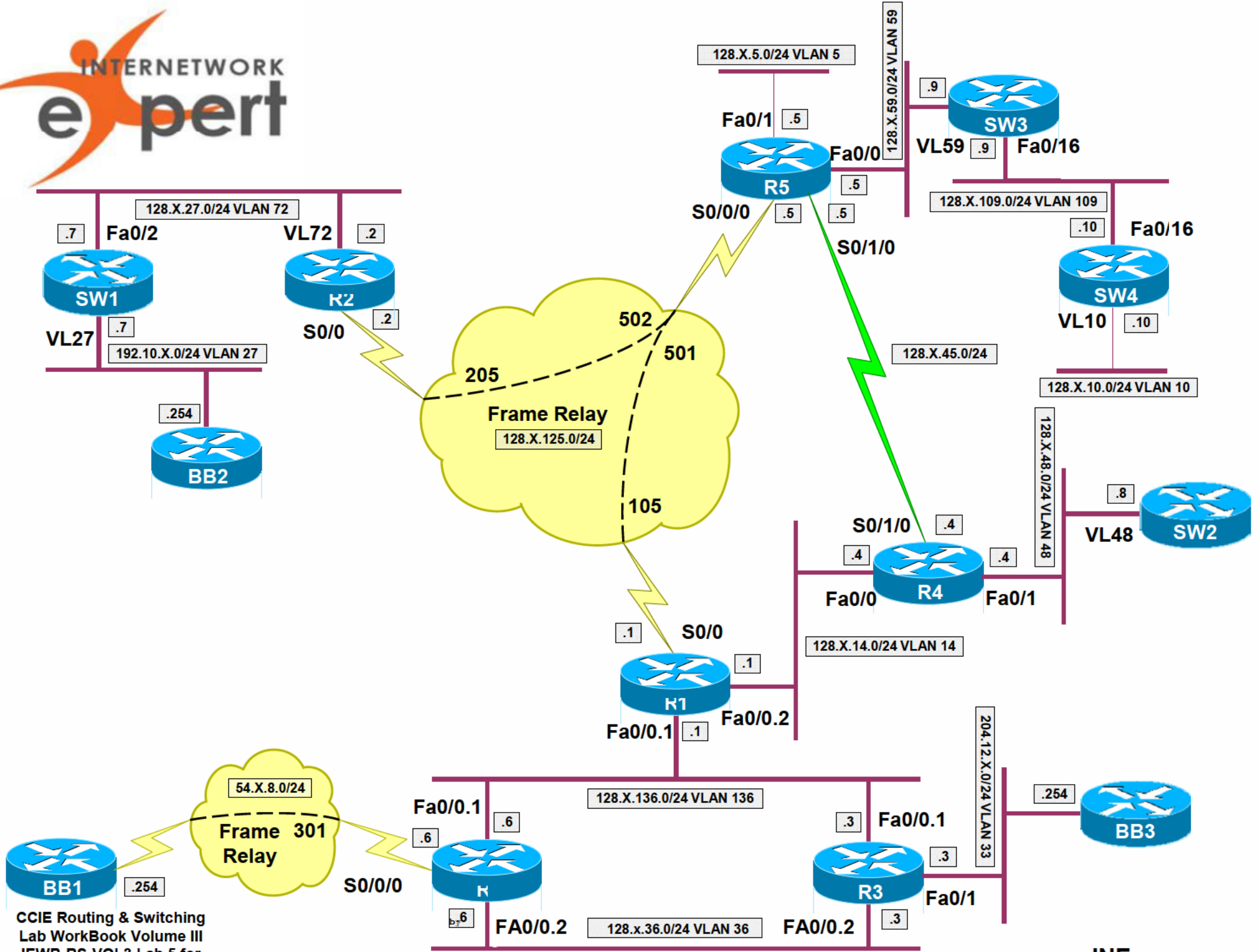

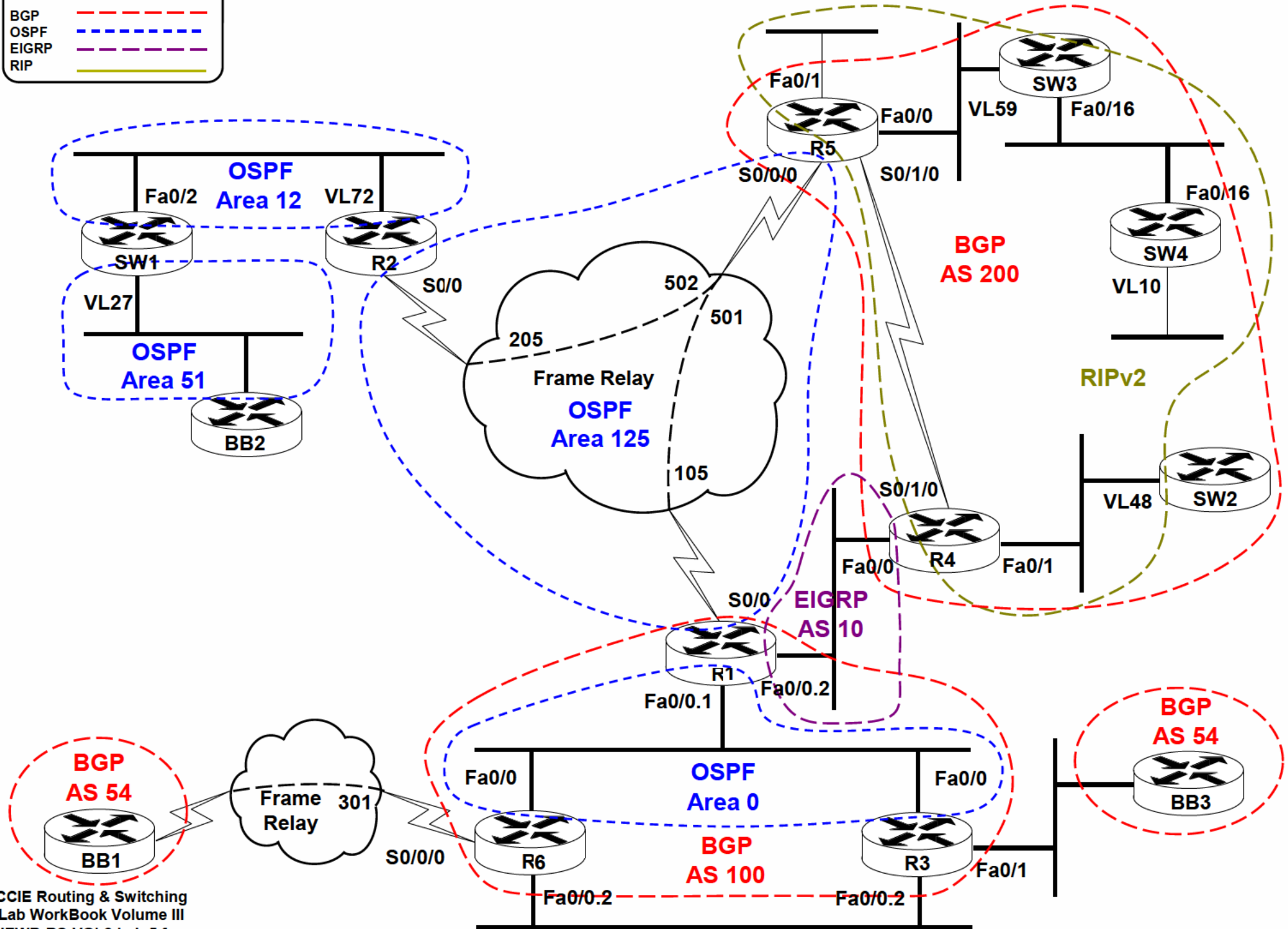
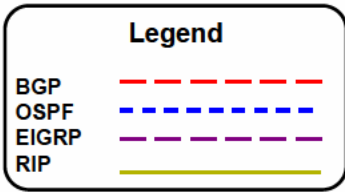

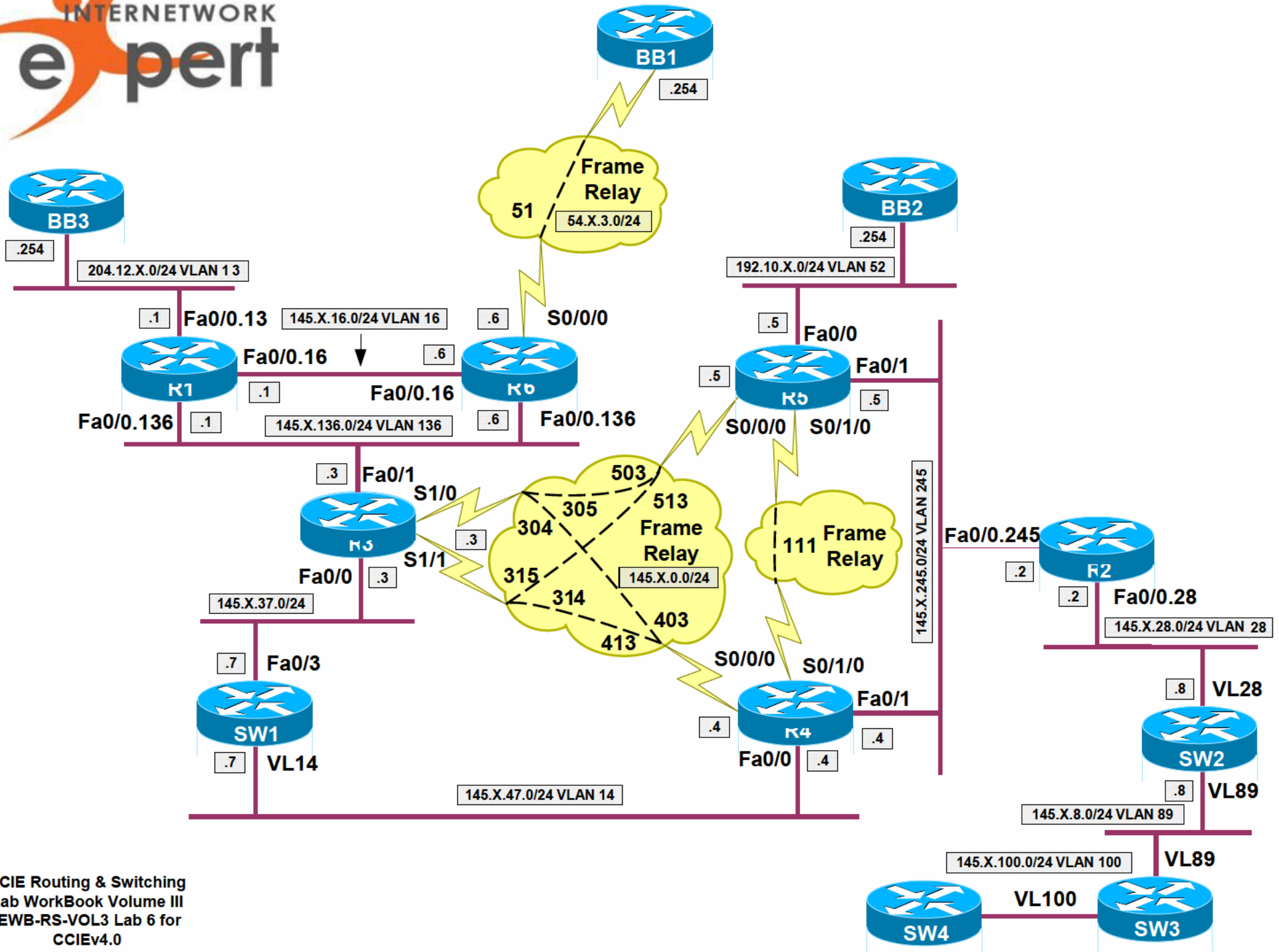

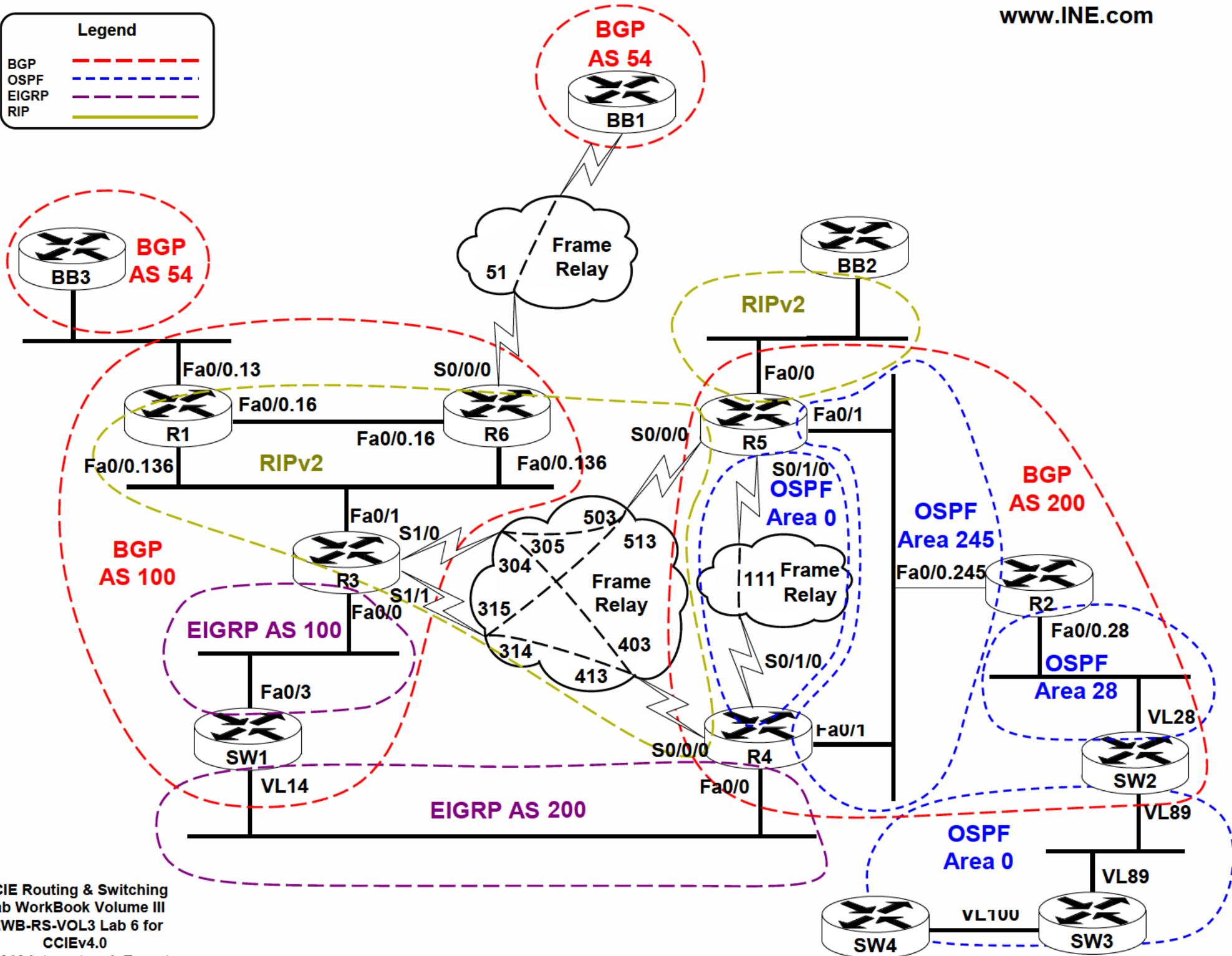
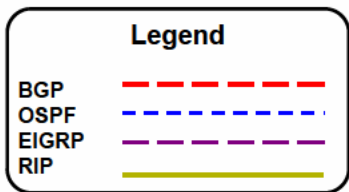

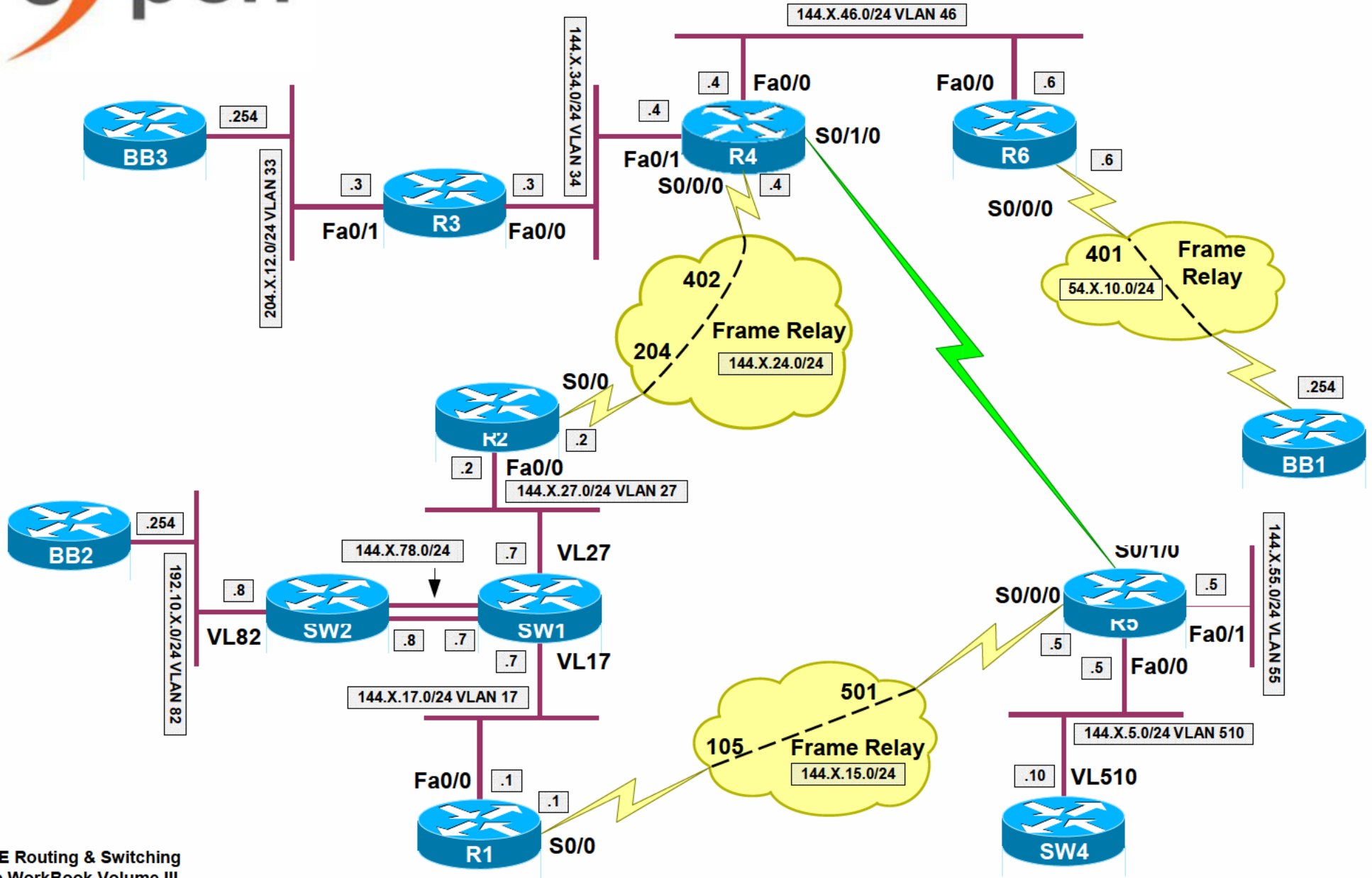

Legend

- BGP (Red dashed line)
- OSPF (Blue dashed line)
- EIGRP (Purple dashed line)
- RIP (Yellow dashed line)

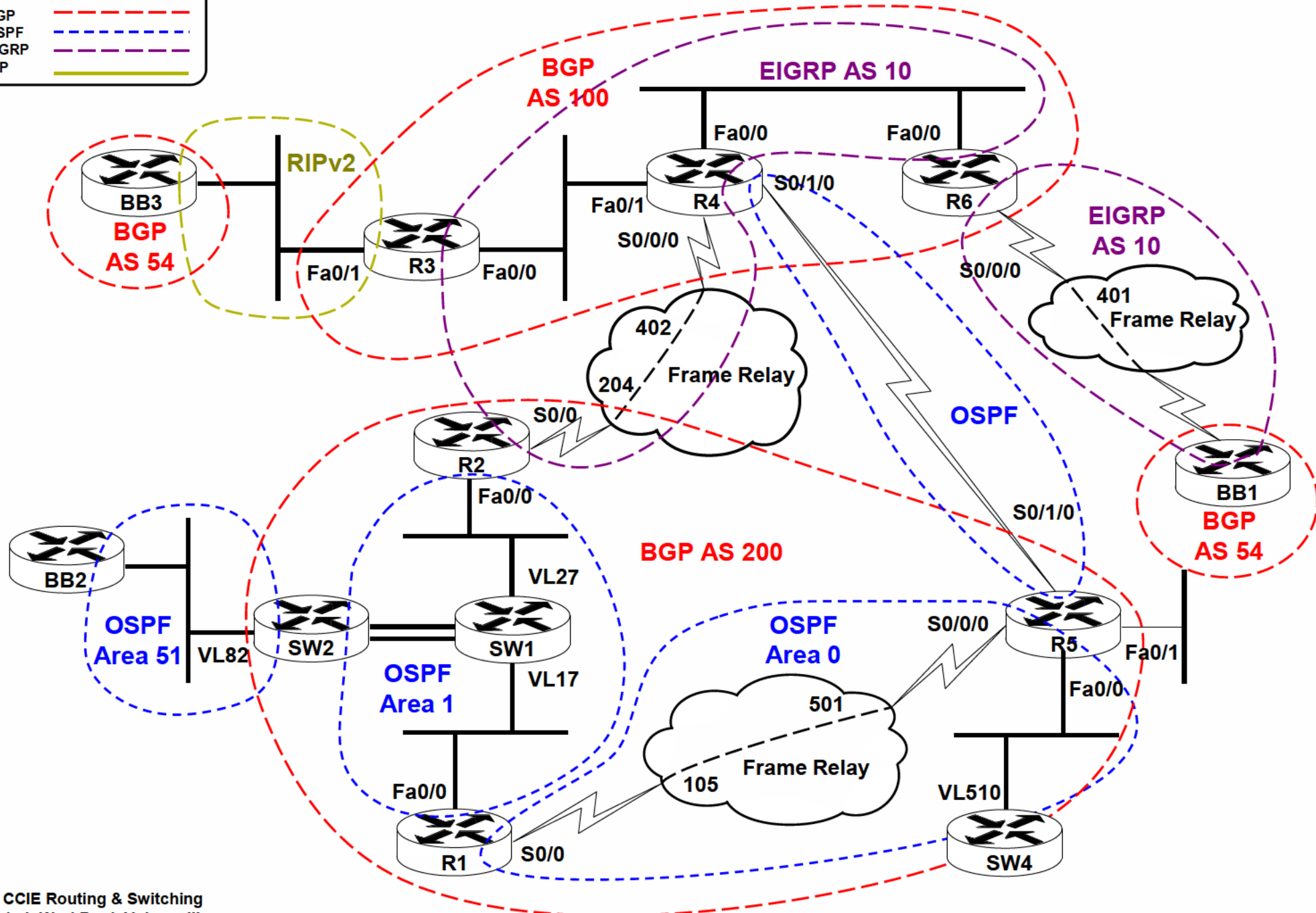



Note: The connection between R1 and R2 will involve configuration on R3. Do not recable your rack for this lab

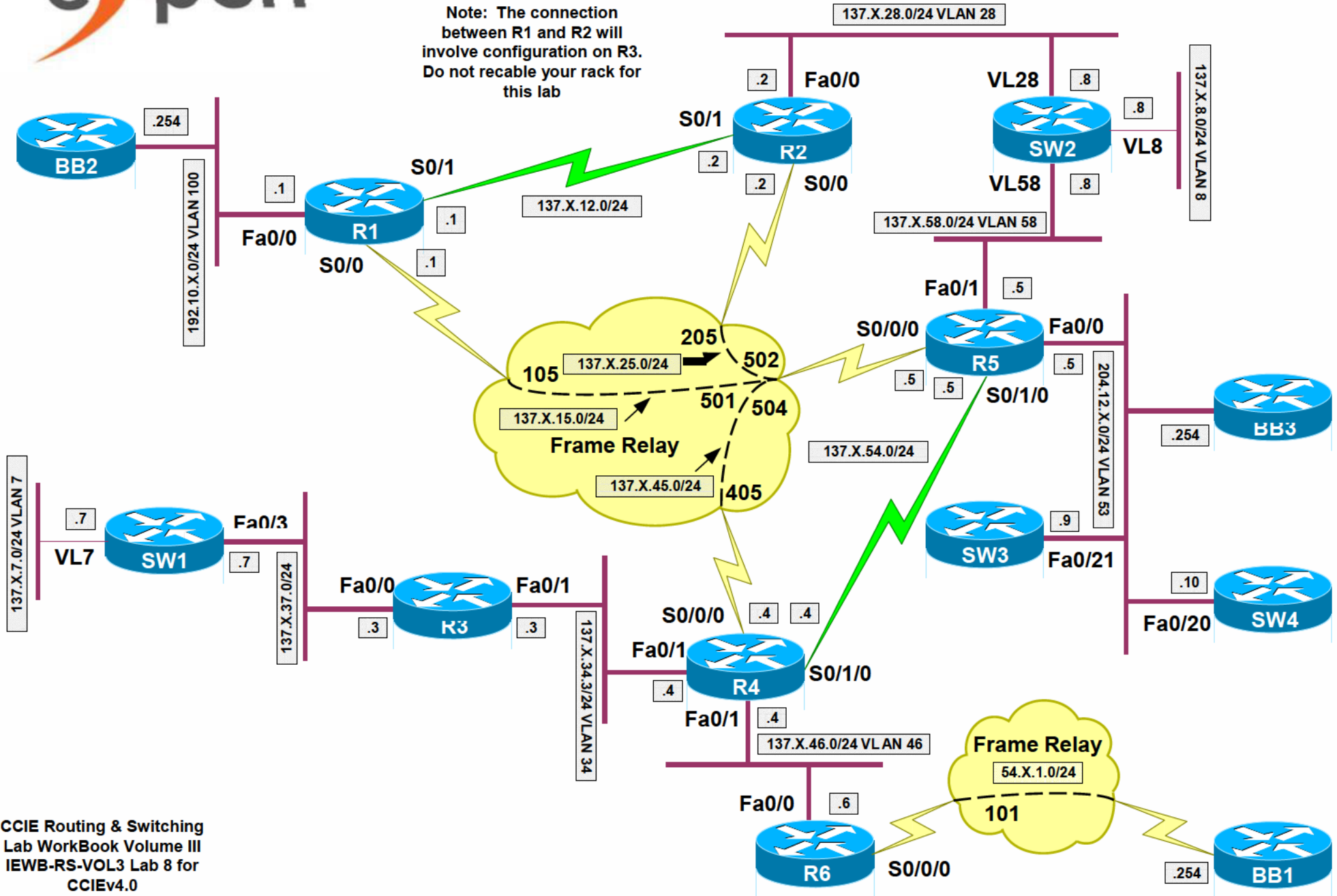

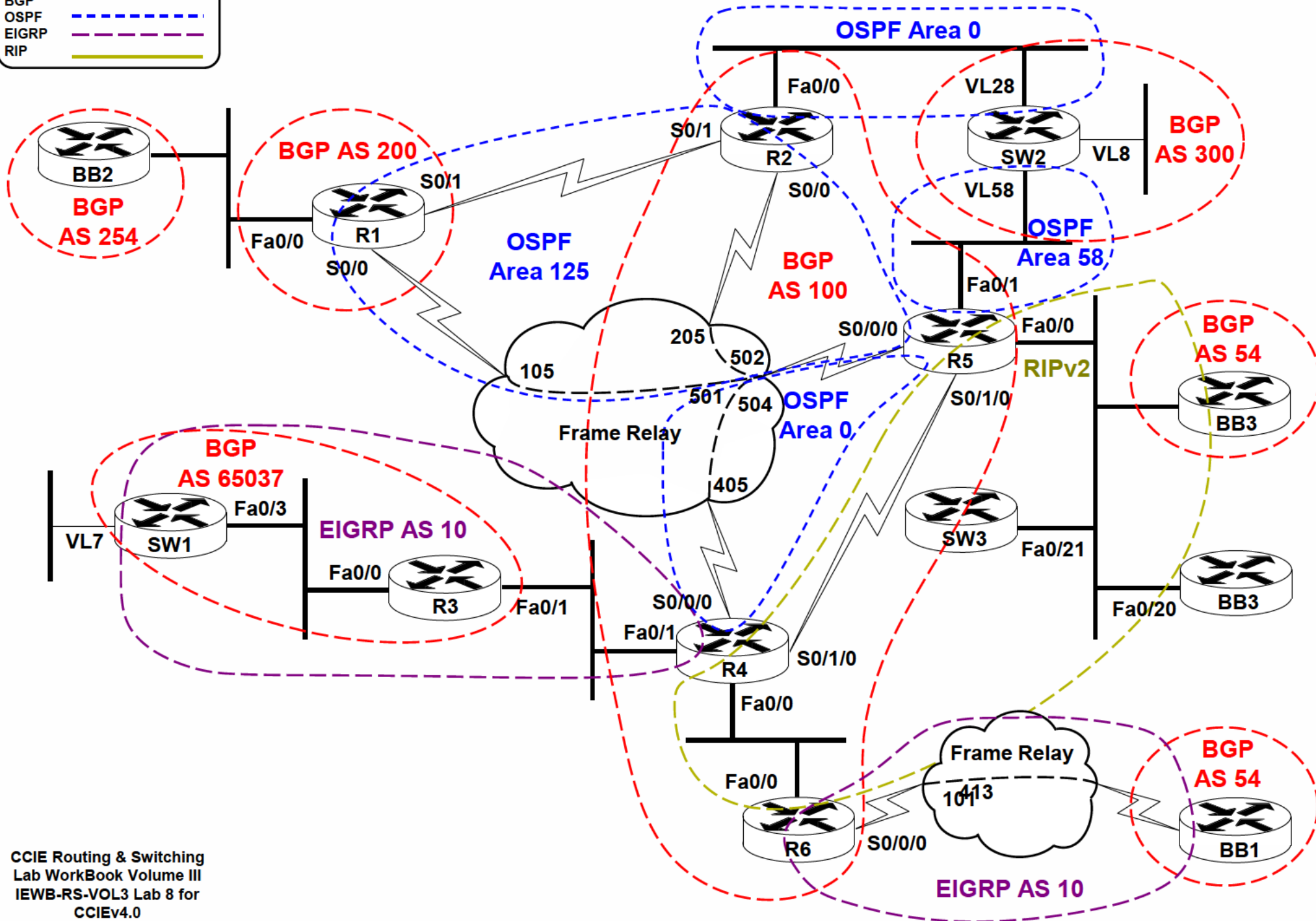
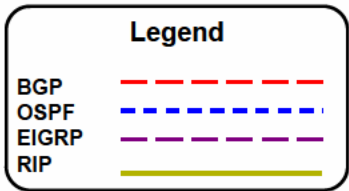

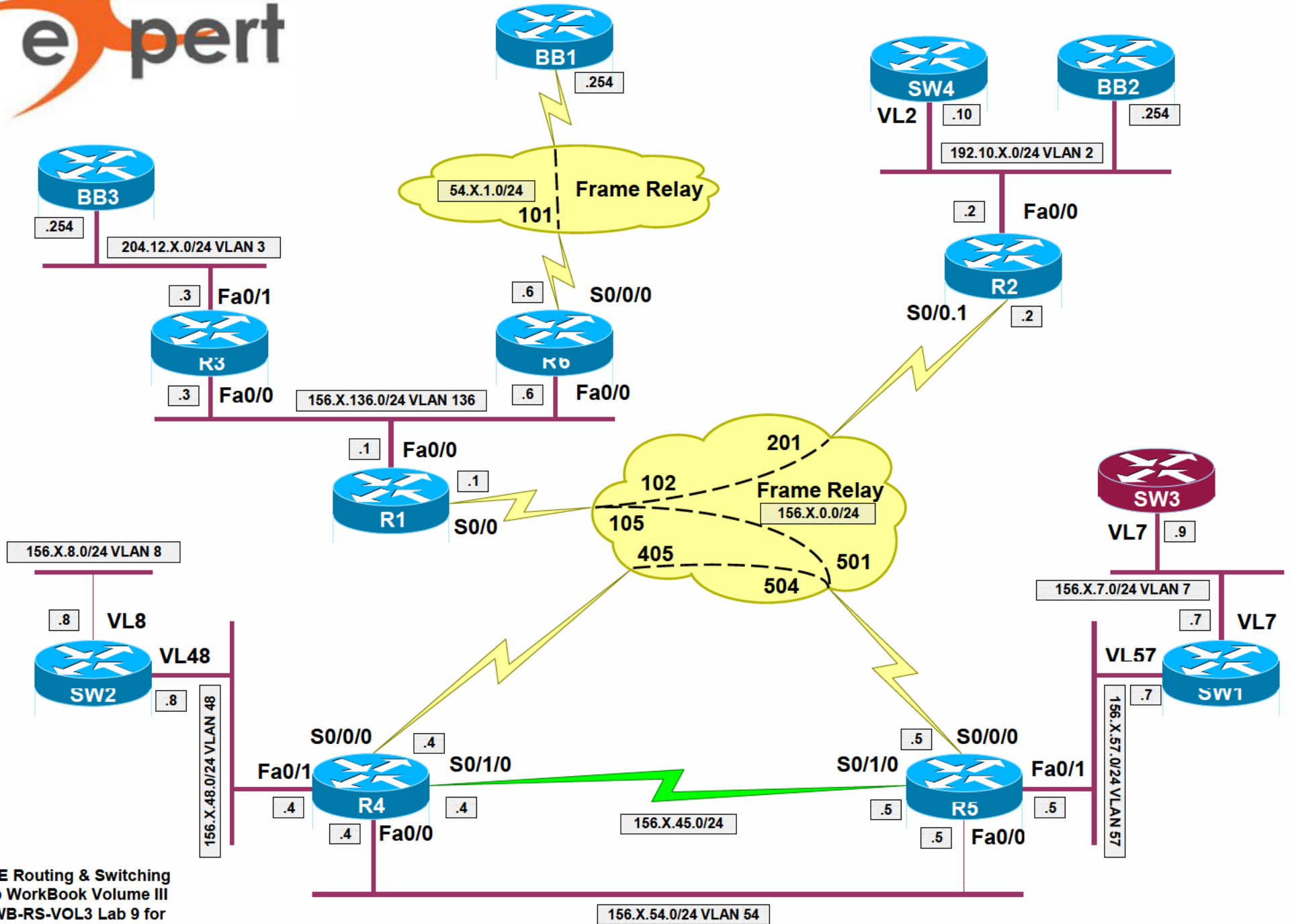

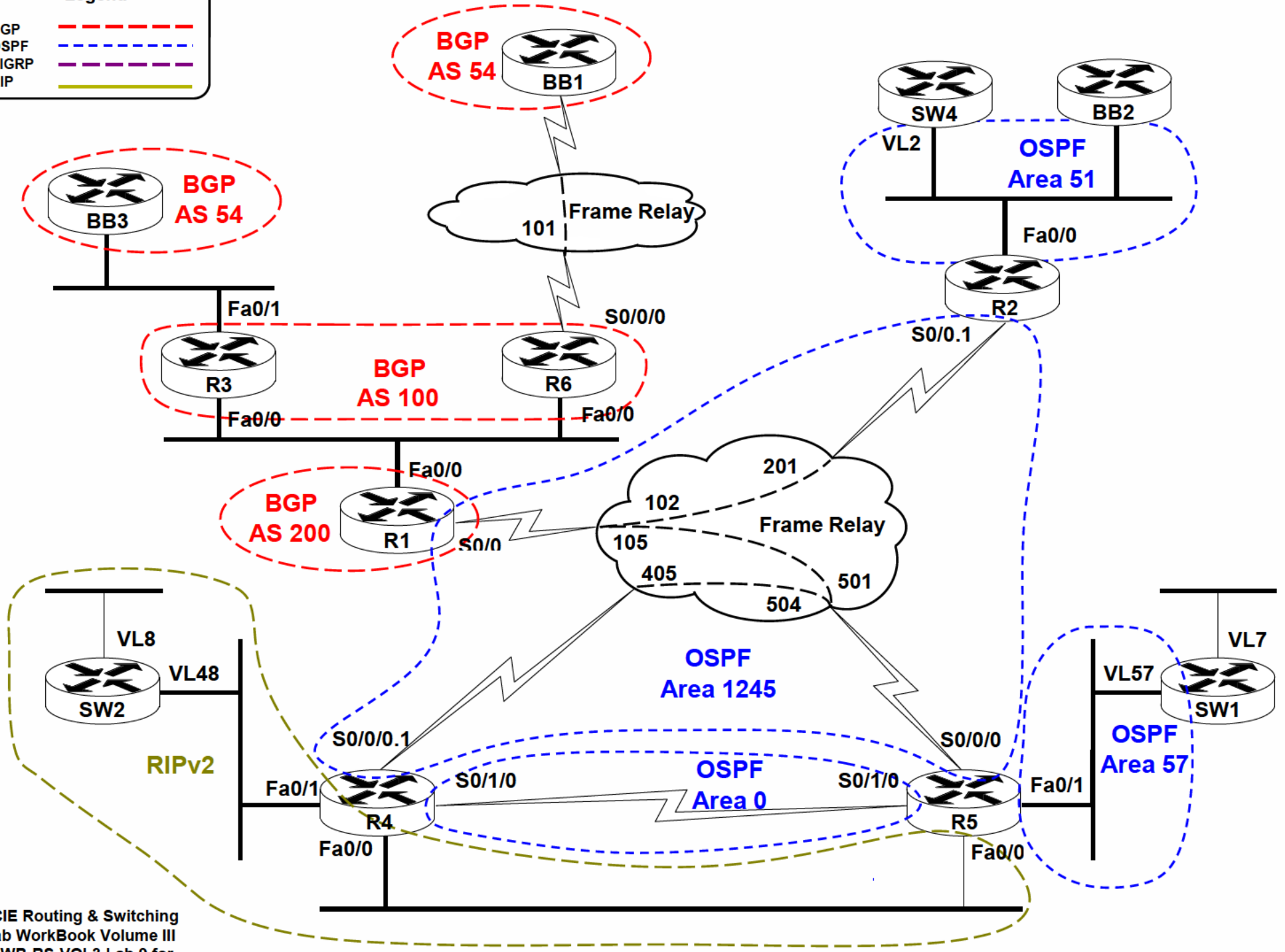
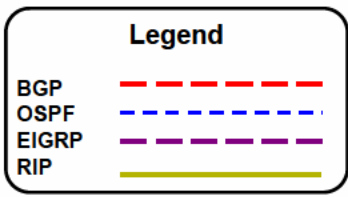

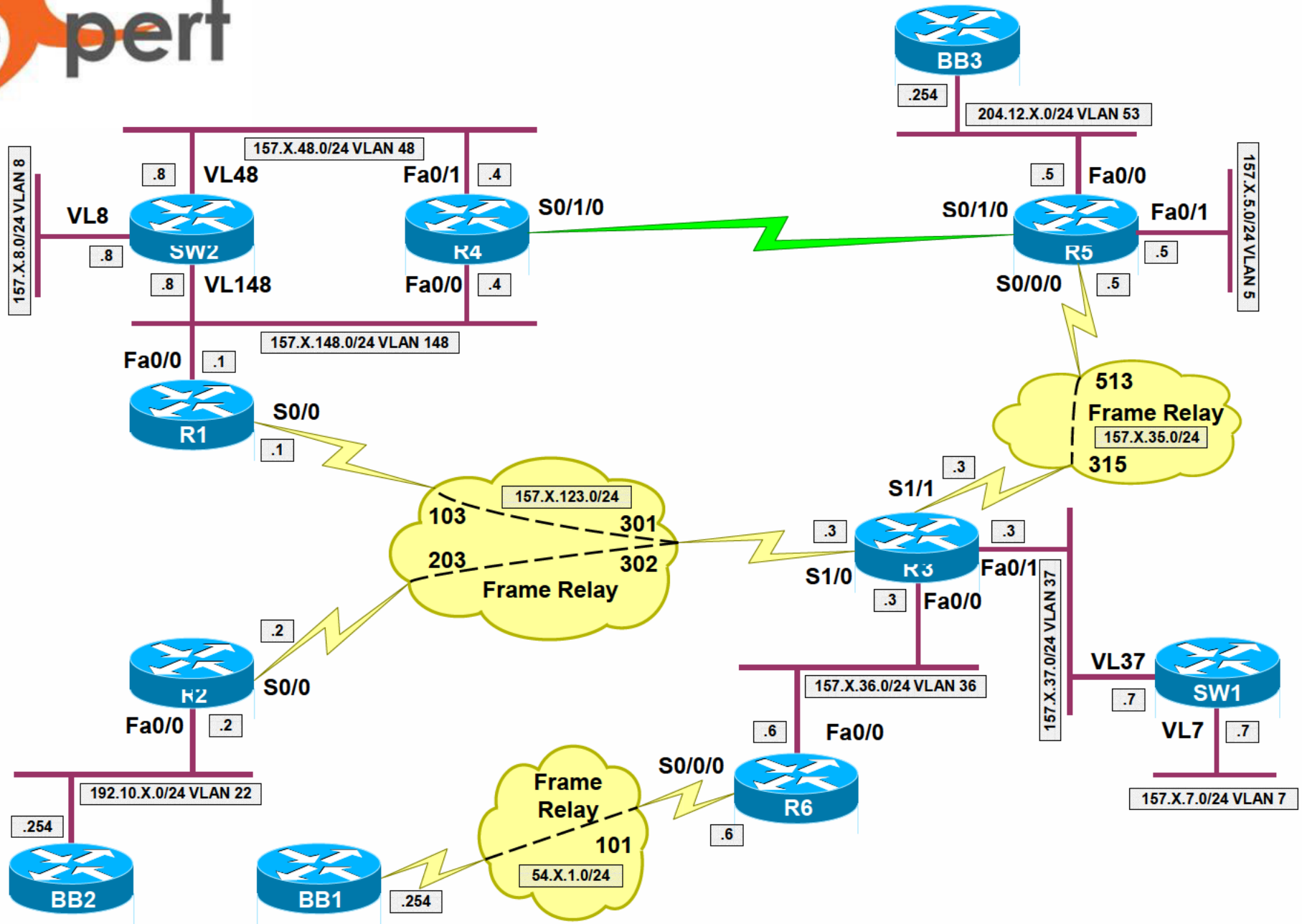

Legend

- BGP (Red dashed line)
- OSPF (Blue dashed line)
- EIGRP (Purple dashed line)
- RIP (Green dashed line)

